

**JOHN DEERE**  
WORLDWIDE COMMERCIAL & CONSUMER  
EQUIPMENT DIVISION

---

**Lawn Tractors**  
**LX255, LX266, LX277, LX277AWS, LX279**  
**and LX288**

TM1754 JANUARY 2003

**TECHNICAL MANUAL**



**JOHN DEERE**

North American Version  
Litho in U.S.A.

# INTRODUCTION

## Manual Description

This technical manual is written for an experienced technician and contains sections that are specifically for this product. It is a part of a total product support program.

The manual is organized so that all the information on a particular system is kept together. The order of grouping is as follows:

- Table of Contents
- Specifications and Information
- Identification Numbers
- Tools and Materials
- Component Location
- Schematics and Harnesses
- Theory of Operation
- Operation and Diagnostics
- Diagnostics
- Tests and Adjustments
- Repair
- Other

**NOTE: Depending on the particular section or system being covered, not all of the above groups may be used.**

The bleed tabs for the pages of each section will align with the sections listed on this page. Page numbering is consecutive from the beginning of the Safety section through the last section.

We appreciate your input on this manual. If you find any errors or want to comment on the layout of the manual please contact us.

Safety

Specifications and Information

Engine - Kohler

Engine - Kawasaki (Air-Cooled)

Engine - Kawasaki (Liquid-Cooled)

Engine - Briggs and Stratton

Electrical

Power Train - Hydrostatic

Steering

Attachments

Miscellaneous

All information, illustrations and specifications in this manual are based on the latest information at the time of publication. The right is reserved to make changes at any time without notice.

COPYRIGHT© 2003  
Deere & Co.

John Deere Worldwide Commercial and  
Consumer Equipment Division

All rights reserved  
Previous Editions  
COPYRIGHT©



# SAFETY

## Recognize Safety Information



MIF

This is the safety-alert symbol. When you see this symbol on your machine or in this manual, be alert to the potential for personal injury.

Follow recommended precautions and safe servicing practices.

## Understand Signal Words

A signal word - DANGER, WARNING, or CAUTION - is used with the safety-alert symbol. DANGER identifies the most serious hazards.

DANGER or WARNING safety signs are located near specific hazards. General precautions are listed on CAUTION safety signs. CAUTION also calls attention to safety messages in this manual.

## Replace Safety Signs

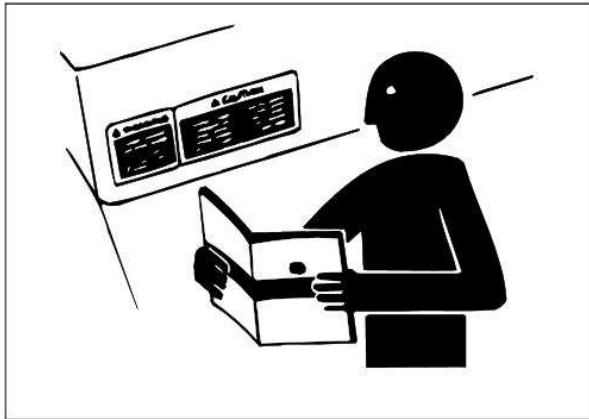

MIF

Replace missing or damaged safety signs. See the machine operator's manual for correct safety sign placement.

## Handle Fluids Safely - Avoid Fires

### Be Prepared For Emergencies

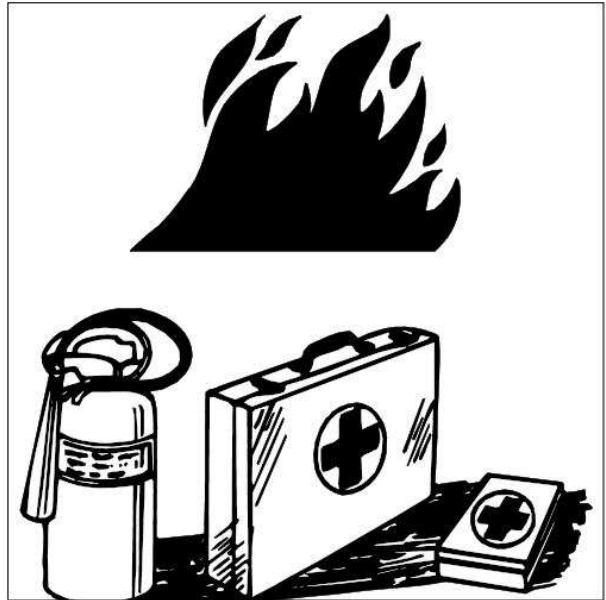

MIF

- When you work around fuel, do not smoke or work near heaters or other fire hazards.
- Store flammable fluids away from fire hazards. Do not incinerate or puncture pressurized containers.
- Make sure machine is clean of trash, grease, and debris.
- Do not store oily rags; they can ignite and burn spontaneously.
- Be prepared if a fire starts.
- Keep a first aid kit and fire extinguisher handy.
- Keep emergency numbers for doctors, ambulance service, hospital, and fire department near your telephone.

## Use Care In Handling and Servicing Batteries

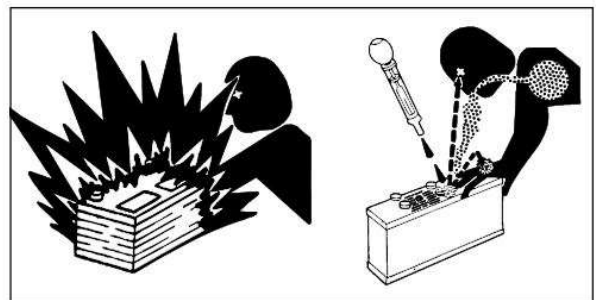

MIF

# SAFETY

## Prevent Battery Explosions

- Keep sparks, lighted matches, and open flame away from the top of battery. Battery gas can explode.
- Never check battery charge by placing a metal object across the posts. Use a volt-meter or hydrometer.
- Do not charge a frozen battery; it may explode. Warm battery to 16°C (60°F).

## Prevent Acid Burns

- Sulfuric acid in battery electrolyte is poisonous. It is strong enough to burn skin, eat holes in clothing, and cause blindness if splashed into eyes.

### Avoid acid burns by:

1. Filling batteries in a well-ventilated area.
2. Wearing eye protection and rubber gloves.
3. Avoiding breathing fumes when electrolyte is added.
4. Avoiding spilling or dripping electrolyte.
5. Use proper jump start procedure.

### If you spill acid on yourself:

1. Flush your skin with water.
2. Apply baking soda or lime to help neutralize the acid.
3. Flush your eyes with water for 10 - 15 minutes.
4. Get medical attention immediately.

### If acid is swallowed:

1. Drink large amounts of water or milk.
2. Then drink milk of magnesia, beaten eggs, or vegetable oil.
3. Get medical attention immediately.

## Wear Protective Clothing

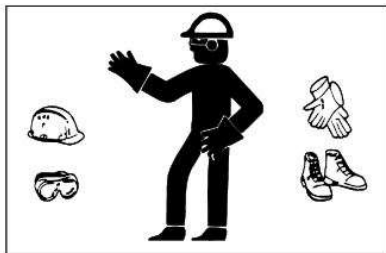

MIF

Wear close fitting clothing and safety equipment appropriate to the job.

Prolonged exposure to loud noise can cause impairment or loss of hearing. Wear a suitable hearing protective device

such as earmuffs or earplugs to protect against objectionable or uncomfortable loud noises.

Operating equipment safely requires the full attention of the operator. Do not wear radio or music headphones while operating machine.

## Use Care Around High-pressure Fluid Lines

### Avoid High-Pressure Fluids



MIF

Escaping fluid under pressure can penetrate the skin causing serious injury.

Avoid injury from escaping fluid under pressure by stopping the engine and relieving pressure in the system before disconnecting or connecting hydraulic or other lines. Tighten all connections before applying pressure.

Search for leaks with a piece of cardboard. Protect hands and body from high pressure fluids.

If an accident occurs, see a doctor immediately. Any fluid injected into the skin must be surgically removed within a few hours or gangrene may result. Doctors unfamiliar with this type of injury should reference a knowledgeable medical source. Such information is available from Deere & Company Medical Department in Moline, Illinois, U.S.A.

### Avoid Heating Near Pressurized Fluid Lines



MIF

Flammable spray can be generated by heating near pressurized fluid lines, resulting in severe burns to yourself and bystanders. Do not heat by welding, soldering, or using a torch near pressurized fluid lines or other flammable materials. Pressurized lines can be accidentally cut when heat goes beyond the immediate flame area.

# SAFETY

## Service Machines Safely

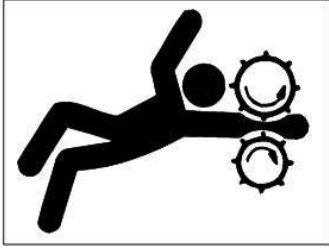

MIF

Tie long hair behind your head. Do not wear a necktie, scarf, loose clothing, or necklace when you work near machine tools or moving parts. If these items were to get caught, severe injury could result.

Remove rings and other jewelry to prevent electrical shorts and entanglement in moving parts.

## Use Proper Tools

Use tools appropriate to the work. Makeshift tools and procedures can create safety hazards. Use power tools only to loosen threaded parts and fasteners. For loosening and tightening hardware, use the correct size tools. **DO NOT** use U.S. measurement tools on metric fasteners. Avoid bodily injury caused by slipping wrenches. Use only service parts meeting John Deere specifications.

## Park Machine Safely

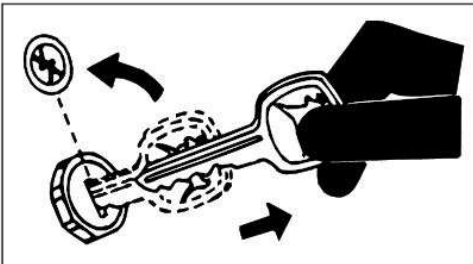

MIF

### Before working on the machine:

1. Lower all equipment to the ground.
2. Stop the engine and remove the key.
3. Disconnect the battery ground strap.
4. Hang a "DO NOT OPERATE" tag in operator station.

## Support Machine Properly and Use Proper Lifting Equipment

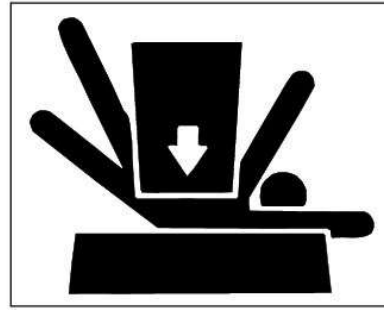

MIF

If you must work on a lifted machine or attachment, securely support the machine or attachment.

Do not support the machine on cinder blocks, hollow tiles, or props that may crumble under continuous load. Do not work under a machine that is supported solely by a jack. Follow recommended procedures in this manual.

Lifting heavy components incorrectly can cause severe injury or machine damage. Follow recommended procedure for removal and installation of components in the manual.

## Work In Clean Area

### Before starting a job:

1. Clean work area and machine.
2. Make sure you have all necessary tools to do your job.
3. Have the right parts on hand.
4. Read all instructions thoroughly; do not attempt shortcuts.

## Using High Pressure Washers

Directing pressurized water at electronic/electrical components or connectors, bearings, hydraulic seals, fuel injection pumps or other sensitive parts and components may cause product malfunctions. Reduce pressure and spray at a 45 to 90 degree angle.

## Illuminate Work Area Safely

Illuminate your work area adequately but safely. Use a portable safety light for working inside or under the machine. Make sure the bulb is enclosed by a wire cage. The hot filament of an accidentally broken bulb can ignite spilled fuel or oil.

# [John Deere LX255 LX266 LX277 Service Manual](#)



Maintenance

Engine

Control System

Mechanical

Fuel Service Specifications

Emission Control

Intake Exhaust Cooling

Lube

Ignition Starting Charging

Auto Transmission Clutch

Manual Transmission

Transfer Propeller Shaft

The manual provides detailed instructions on tasks such as checking fluid levels, inspecting key components, and performing basic troubleshooting. Following these guidelines not only extends the life of the equipment but also prevents costly breakdowns.

**[John Deere LX255 LX266 LX277 Service Manual](#)**

# SAFETY

## Work In Ventilated Area

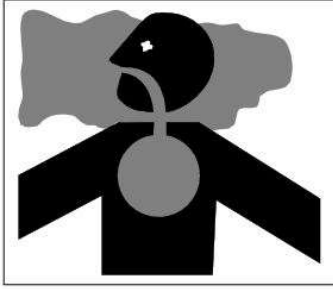

MIF

Engine exhaust fumes can cause sickness or death. If it is necessary to run an engine in an enclosed area, remove the exhaust fumes from the area with an exhaust pipe extension.

If you do not have an exhaust pipe extension, open the doors and get outside air into the area.

### Warning: California Proposition 65 Warning

Gasoline engine exhaust from this product contains chemicals known to the State of California to cause cancer, birth defects, or other reproductive harm.

Diesel engine exhaust and some of its constituents are known to the State of California to cause cancer, birth defects, and other reproductive harm.

### Remove Paint Before Welding or Heating

Avoid potentially toxic fumes and dust. Hazardous fumes can be generated when paint is heated by welding, soldering, or using a torch. Do all work outside or in a well ventilated area. Dispose of paint and solvent properly. Remove paint before welding or heating: If you sand or grind paint, avoid breathing the dust. Wear an approved respirator. If you use solvent or paint stripper, remove stripper with soap and water before welding. Remove solvent or paint stripper containers and other flammable material from area. Allow fumes to disperse at least 15 minutes before welding or heating.

## Avoid Harmful Asbestos Dust

Avoid breathing dust that may be generated when handling components containing asbestos fibers. Inhaled asbestos fibers may cause lung cancer.

Components in products that may contain asbestos fibers are brake pads, brake band and lining assemblies, clutch plates, and some gaskets. The asbestos used in these components is usually found in a resin or sealed in some way. Normal handling is not hazardous as long as airborne dust containing asbestos is not generated.

Avoid creating dust. Never use compressed air for cleaning. Avoid brushing or grinding material containing asbestos. When servicing, wear an approved respirator. A special vacuum cleaner is recommended to clean asbestos. If not available, apply a mist of oil or water on the material containing asbestos. Keep bystanders away from the area.

## Service Tires Safely



MIF

Explosive separation of a tire and rim parts can cause serious injury or death.

Do not attempt to mount a tire unless you have the proper equipment and experience to perform the job.

Always maintain the correct tire pressure. Do not inflate the tires above the recommended pressure. Never weld or heat a wheel and tire assembly. The heat can cause an increase in air pressure resulting in a tire explosion. Welding can structurally weaken or deform the wheel.

When inflating tires, use a clip-on chuck and extension hose long enough to allow you to stand to one side and NOT in front of or over the tire assembly. Use a safety cage if available.

Check wheels for low pressure, cuts, bubbles, damaged rims or missing lug bolts and nuts.



# SAFETY

## Avoid Injury From Rotating Blades, Augers and PTO Shafts

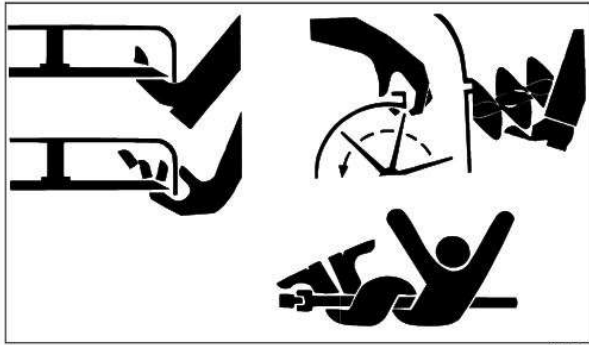

MIF

Keep hands and feet away while machine is running. Shut off power to service, lubricate or remove mower blades, augers or PTO shafts.

## Service Cooling System Safely



MIF

Explosive release of fluids from pressurized cooling system can cause serious burns.

Shut off machine. Only remove filler cap when cool enough to touch with bare hands. Slowly loosen cap to first stop to relieve pressure before removing completely.

## Handle Chemical Products Safely

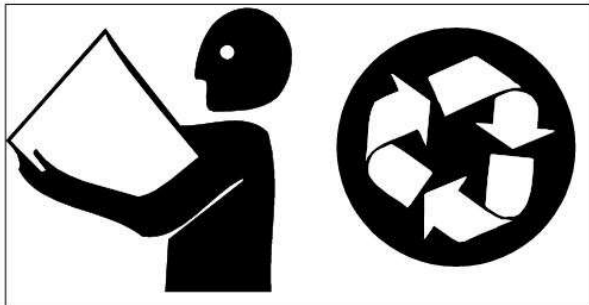

MIF

Direct exposure to hazardous chemicals can cause serious injury. Potentially hazardous chemicals used with John Deere equipment include such items as lubricants, coolants, paints, and adhesives.

A Material Safety Data Sheet (MSDS) provides specific details on chemical products: physical and health hazards, safety procedures, and emergency response techniques. Check the MSDS before you start any job using a hazardous chemical. That way you will know exactly what the risks are and how to do the job safely. Then follow procedures and recommended equipment.

## Dispose of Waste Properly

Improperly disposing of waste can threaten the environment and ecology. Potentially harmful waste used with John Deere equipment include such items as oil, fuel, coolant, brake fluid, filters, and batteries. Use leakproof containers when draining fluids. Do not use food or beverage containers that may mislead someone into drinking from them. Do not pour waste onto the ground, down a drain, or into any water source. Inquire on the proper way to recycle or dispose of waste from your local environmental or recycling center, or from your John Deere dealer.

## Live With Safety



MIF

Before returning machine to customer, make sure machine is functioning properly, especially the safety systems. Install all guards and shields.

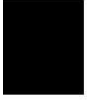

# SPECIFICATIONS & INFORMATION TABLE OF CONTENTS

---

## Table of Contents

<b>Fastener Torques.....</b>	<b>9</b>
Metric Fastener Torque Values .....	9
Inch Fastener Torque Values .....	10
<b>O-Ring Seal Service Recommendations .....</b>	<b>11</b>
Face Seal Fittings	
With Inch Stud Ends Torque .....	11
Face Seal Fittings	
With Metric Stud Ends Torque .....	12
O-ring Face Seal Fittings.....	13
O-Ring Boss Fittings .....	13
Straight Fitting or Special Nut Torques .....	14
Metric Fastener Torque Value -	
Grade 7 (Special) .....	14
<b>General Information.....</b>	<b>14</b>
Gasoline .....	14
Gasoline Storage.....	15
4 - Cycle Gasoline Engine Oil .....	15
Break-In Engine Oil - 4-Cycle Gasoline.....	16
Hydrostatic Transmission and	
Hydraulic Oil .....	16
Gear Case Oil.....	17
Gear Transmission Grease .....	18
Alternative Lubricants .....	18
Synthetic Lubricants .....	18
Lubricant Storage .....	18
Mixing of Lubricants .....	18
Oil Filters .....	18
<b>Coolant Specifications .....</b>	<b>19</b>
Gasoline Engine Coolant.....	19
Gasoline Engine	
Coolant Drain Interval.....	19
<b>Serial Number Locations .....</b>	<b>20</b>
Product Serial Number .....	20
Gasoline Engine	
Serial Number Location.....	20



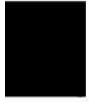

# SPECIFICATIONS & INFORMATION FASTENER TORQUES

## Fastener Torques

### Metric Fastener Torque Values

Property Class and Head Markings					
Property Class and Nut Markings					

MIF

SIZE	Class 4.8				Class 8.8 or 9.8				Class 10.9				Class 12.9			
	Lubricated a		Dry a		Lubricated a		Dry a		Lubricated a		Dry a		Lubricated a		Dry a	
	N•m	lb-ft	N•m	lb-ft	N•m	lb-ft	N•m	lb-ft	N•m	lb-ft	N•m	lb-ft	N•m	lb-ft	N•m	lb-ft
M6	4.8	3.5	6	4.5	9	6.5	11	8.5	13	9.5	17	12	15	11.5	19	14.5
M8	12	8.5	15	11	22	16	28	20	32	24	40	30	37	28	47	35
M10	23	17	29	21	43	32	55	40	63	47	80	60	75	55	95	70
M12	40	29	50	37	75	55	95	70	110	80	140	105	130	95	165	120
M14	63	47	80	60	120	88	150	110	175	130	225	165	205	150	260	109
M16	100	73	125	92	190	140	240	175	275	200	350	225	320	240	400	300
M18	135	100	175	125	260	195	330	250	375	275	475	350	440	325	560	410
M20	190	140	240	180	375	275	475	350	530	400	675	500	625	460	800	580
M22	260	190	330	250	510	375	650	475	725	540	925	675	850	625	1075	800
M24	330	250	425	310	650	475	825	600	925	675	1150	850	1075	800	1350	1000
M27	490	360	625	450	950	700	1200	875	1350	1000	1700	1250	1600	1150	2000	1500
M30	675	490	850	625	1300	950	1650	1200	1850	1350	2300	1700	2150	1600	2700	2000
M33	900	675	1150	850	1750	1300	2200	1650	2500	1850	3150	2350	2900	2150	3700	2750
M36	1150	850	1450	1075	2250	1650	2850	2100	3200	2350	4050	3000	3750	2750	4750	3500

DO NOT use these hand torque values if a different torque value or tightening procedure is given for a specific application. Torque values listed are for general use only and include a ±10% variance factor. Check tightness of fasteners periodically. DO NOT use air powered wrenches.

Shear bolts are designed to fail under predetermined loads. Always replace shear bolts with identical grade.

Fasteners should be replaced with the same grade. Make sure fastener threads are clean and that you properly start thread engagement. This will prevent them from failing when tightening.

When bolt and nut combination fasteners are used, torque values should be applied to the NUT instead of the bolt head.









Tighten toothed or serrated-type lock nuts to the full torque value.

a "Lubricated" means coated with a lubricant such as engine oil, or fasteners with phosphate and oil coatings. "Dry" means plain or zinc plated (yellow dichromate - Specification JDS117) without any lubrication.

Reference: JDS - G200.

# SPECIFICATIONS & INFORMATION FASTENER TORQUES

## Inch Fastener Torque Values

SAE Grade and Head Markings	1 or 2 <sup>b</sup> No Marks 	5    5.1    5.2 	8    8.2 
SAE Grade and Nut Markings	2 No Marks 	5  	8  

MIF

SIZE	Grade 1		Grade 2b				Grade 5, 5.1 or 5.2				Grade 8 or 8.2					
	Lubricated a		Dry a		Lubricated a		Dry a		Lubricated a		Dry a		Lubricated a		Dry a	
	N•m	lb-ft	N•m	lb-ft	N•m	lb-ft	N•m	lb-ft	N•m	lb-ft	N•m	lb-ft	N•m	lb-ft	N•m	lb-ft
1/4	3.7	2.8	4.7	3.5	6	4.5	7.5	5.5	9.5	7	12	9	13.5	10	17	12.5
5/16	7.7	5.5	10	7	12	9	15	11	20	15	25	18	28	21	35	26
3/8	14	10	17	13	22	16	27	20	35	26	44	33	50	36	63	46
7/16	22	16	28	20	35	26	44	32	55	41	70	52	80	58	100	75
1/2	33	25	42	31	53	39	67	50	85	63	110	80	120	90	150	115
9/16	48	36	60	45	75	56	95	70	125	90	155	115	175	130	225	160
5/8	67	50	85	62	105	78	135	100	170	125	215	160	215	160	300	225
3/4	120	87	150	110	190	140	240	175	300	225	375	280	425	310	550	400
7/8	190	140	240	175	190	140	240	175	490	360	625	450	700	500	875	650
1	290	210	360	270	290	210	360	270	725	540	925	675	1050	750	1300	975
1-1/8	470	300	510	375	470	300	510	375	900	675	1150	850	1450	1075	1850	1350
1-1/4	570	425	725	530	570	425	725	530	1300	950	1650	1200	2050	1500	2600	1950
1-3/8	750	550	950	700	750	550	950	700	1700	1250	2150	1550	2700	2000	3400	2550
1-1/2	1000	725	1250	925	990	725	1250	930	2250	1650	2850	2100	3600	2650	4550	3350

DO NOT use these hand torque values if a different torque value or tightening procedure is given for a specific application. Torque values listed are for general use only and include a ±10% variance factor. Check tightness of fasteners periodically. DO NOT use air powered wrenches.

Shear bolts are designed to fail under predetermined loads. Always replace shear bolts with identical grade.

Fasteners should be replaced with the same grade. Make sure fastener threads are clean and that you properly start thread engagement. This will prevent them from failing when tightening.

When bolt and nut combination fasteners are used, torque values should be applied to the NUT instead of the bolt

head.

Tighten toothed or serrated-type lock nuts to the full torque value.

a "Lubricated" means coated with a lubricant such as engine oil, or fasteners with phosphate and oil coatings. "Dry" means plain or zinc plated (yellow dichromate - Specification JDS117) without any lubrication.

b "Grade 2" applies for hex cap screws (Not Hex Bolts) up to 152 mm (6 in.) long. "Grade 1" applies for hex cap screws over 152 mm (6 in.) long, and for all other types of bolts and screws of any length.

Reference: JDS - G200

# SPECIFICATIONS & INFORMATION O-RING SEAL SERVICE

## O-Ring Seal Service Recommendations

### Face Seal Fittings With Inch Stud Ends Torque

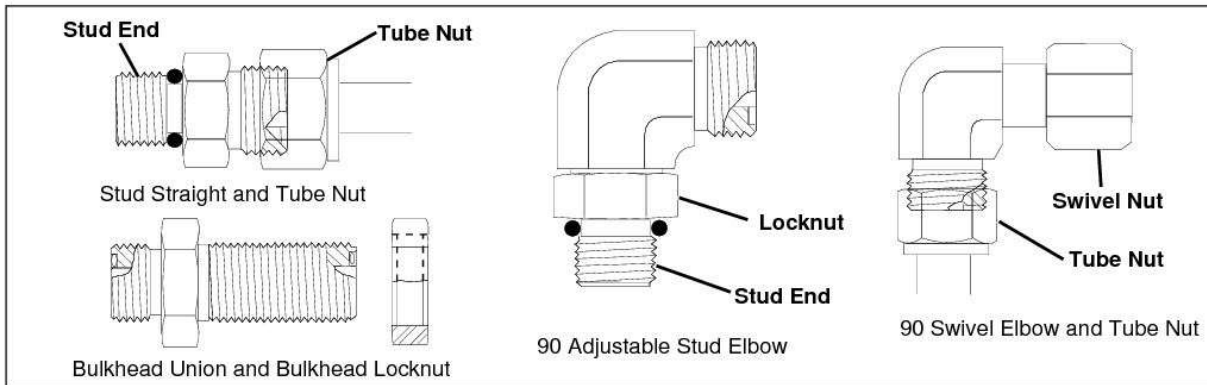

MIF

Nominal Tube OD/Hose ID				Face Seal Tube/Hose End					O-Ring Stud Ends		
Metric Tube OD	Inch Tube OD			Thread Size	Tube Nut/ Swivel Nut Torque		Bulkhead Lock Nut Torque		Thread Size	Straight Fitting or Lock Nut Torque	
	Dash Size	in.	mm		in.	N·m	lb-ft	N·m		lb-ft	in.
5	-3	0.188	4.76						3/8-24	8	6
6	-4	0.250	6.35	9/16-18	16	12	12	9	7/16-20	12	9
8	-5	0.312	7.94						1/2-20	16	12
10	-6	0.375	9.52	11/16-16	24	18	24	18	9/16-18	24	18
12	-8	0.500	12.70	13/16-16	50	37	46	34	3/4-16	46	34
16	-10	0.625	15.88	1-14	69	51	62	46	7/8-14	62	46
19	-12	0.750	19.05	1-3/16-12	102	75	102	75	1-1/16-12	102	75
22	-14	0.875	22.22	1-3/16-12	102	75	102	75	1-3/16-12	122	90
25	-16	1.000	25.40	1-7/16-12	142	105	142	105	1-5/16-12	142	105
32	-20	1.25	31.75	1-11/16-12	190	140	190	140	1-5/8-12	190	140
38	-24	1.50	38.10	2-12	217	160	217	160	1-7/8-12	217	160

**NOTE: Torque tolerance is +15%, -20%**

# SPECIFICATIONS & INFORMATION O-RING SEAL SERVICE

## Face Seal Fittings With Metric Stud Ends Torque

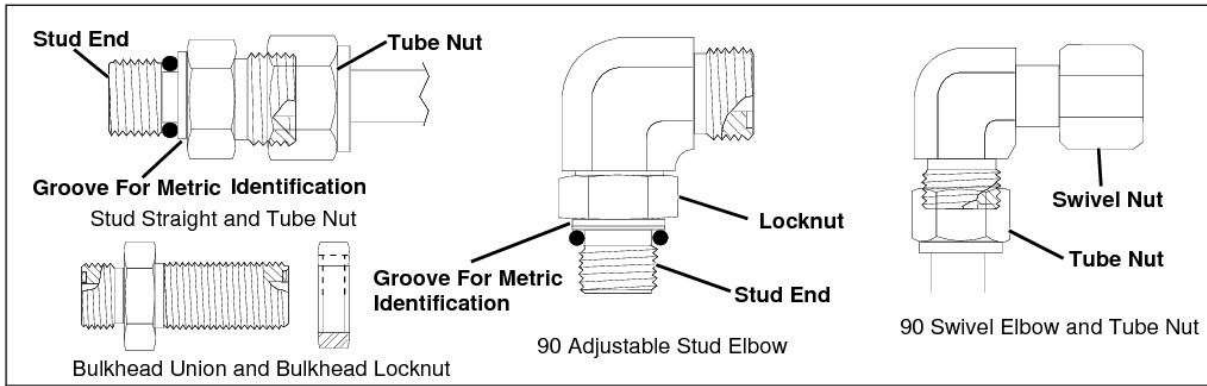

MIF

Nominal Tube OD/Hose ID				Face Seal Tube/Hose End						O-Ring Stud Ends, Straight Fitting or Lock Nut					
Metric Tube OD	Inch Tube OD			Thread Size	Hex Size	Tube Nut/ Swivel Nut Torque		Bulkhead Lock Nut Torque		Thread Size	Hex Size	Steel or Gray Iron Torque		Aluminum Torque	
	mm	Dash Size	in.			mm	in.	mm	N·m			lb-ft	N·m	lb-ft	mm
6	-4	0.250	6.35	9/16-18	17	16	12	12	9	M12X1.5	17	21	15.5	9	6.6
8	-5	0.312	7.94							M14X1.5	19	33	24	15	11
10	-6	0.375	9.52	11/16-16	22	24	18	24	18	M16X1.5	22	41	30	18	13
12	-8	0.500	12.70	13/16-16	24	50	37	46	34	M18X1.5	24	50	37	21	15
16	-10	0.625	15.88	1-14	30	69	51	62	46	M22X1.5	27	69	51	28	21
	-12	0.750	19.05	1-3/16-12	36	102	75	102	75	M27X2	32	102	75	46	34
22	-14	0.875	22.22	1-3/16-12	36	102	75	102	75	M30X2	36				
25	-16	1.000	25.40	1-7/16-12	41	142	105	142	105	M33X2	41	158	116	71	52
28										M38X2	46	176	130	79	58
32	-20	1.25	31.75	1-11/16-12	50	190	140	190	140	M42X2	50	190	140	85	63
38	-24	1.50	38.10	2-12	60	217	160	217	160	M48X2	55	217	160	98	72

**NOTE: Torque tolerance is +15%, -20%**



# SPECIFICATIONS & INFORMATION O-RING SEAL SERVICE

## O-ring Face Seal Fittings

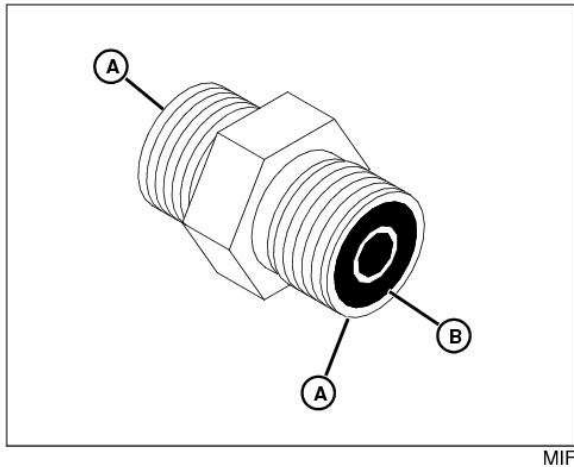

MIF

1. Inspect the fitting sealing surfaces (A). They must be free of dirt or defects.
2. Inspect the O-ring (B). It must be free of damage or defects.
3. Lubricate O-rings and install into groove using petroleum jelly to hold in place during assembly.
4. Index angle fittings and tighten by hand pressing joint together to insure O-ring remains in place.

**IMPORTANT: Avoid damage! DO NOT allow hoses to twist when tightening fittings. Use two wrenches to tighten hose connections; one to hold the hose, and the other to tighten the swivel fitting.**

5. Tighten fitting or nut to torque value shown on the chart per dash size stamped on the fitting.

## O-Ring Boss Fittings

1. Inspect boss O-ring boss seat. It must be free of dirt and defects. If repeated leaks occur, inspect for defects with a magnifying glass. Some raised defects can be removed with a slip stone.

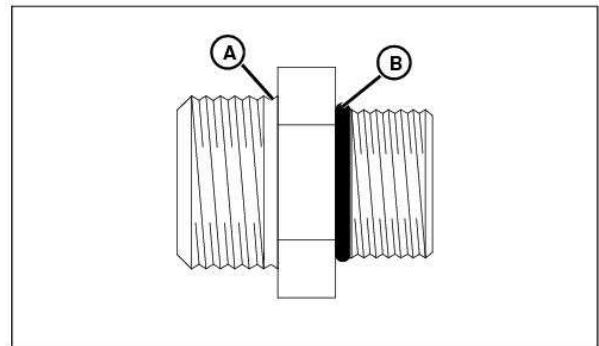

MIF

2. Put hydraulic oil or petroleum jelly on the O-ring (B). Place electrical tape over the threads to protect O-ring from nicks. Slide O-ring over the tape and into the groove (A) of fitting. Remove tape.

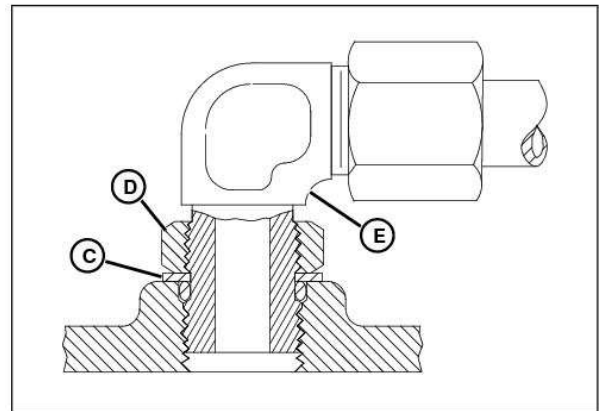

MIF

3. For angle fittings, loosen special nut (D) and push special washer (C) against threads so O-ring can be installed into the groove of fitting.
4. Turn fitting into the boss by hand until special washer or washer face (straight fitting) contacts boss face and O-ring is squeezed into its seat.
5. To position angle fittings (E), turn the fitting counter-clockwise a maximum of one turn.
6. Tighten straight fittings to torque value shown on chart. For angle fittings, tighten the special nut to value shown in the chart while holding body of fitting with a wrench.

# SPECIFICATIONS & INFORMATION GENERAL INFORMATION

## Straight Fitting or Special Nut Torques

Thread Size	Torque <sup>a</sup>		Number of Flats <sup>b</sup>
	N•m	lb-ft	
3/8-24 UNF	8	6	2
7/16-20 UNF	12	9	2
1/2-20 UNF	16	12	2
9/16-18 UNF	24	18	2
3/4-16 UNF	46	34	2
7/8-14 UNF	62	46	1-1/2
1-1/16-12 UN	102	75	1
1-3/16-12 UN	122	90	1
1-5/16-12 UN	142	105	3/4
1-5/8-12 UN	190	140	3/4
1-7/8-12 UN	217	160	1/2

<sup>a</sup>Torque tolerance is ± 10 percent.

<sup>b</sup>To be used if a torque wrench cannot be used. After tightening fitting by hand, put a mark on nut or boss; then tighten special nut or straight fitting the number of flats shown.

## Metric Fastener Torque Value - Grade 7 (Special)

Size	Steel or Gray Iron Torque	Aluminum Torque
	N•m (lb-ft)	N•m (lb-ft)
M6	11 (8)	8 (6)
M8	24 (18)	19 (14)
M10	52 (38)	41 (30)
M12	88 (65)	70 (52)
M14	138 (102)	111 (82)
M16	224 (165)	179 (132)

## General Information

### Gasoline

#### 4 - Cycle Engines



**CAUTION: Avoid Injury! Gasoline is HIGHLY FLAMMABLE**, handle it with care. **DO NOT** refuel machine while: indoors, always fill gas tank outdoors; machine is near an open flame or sparks; engine is running, **STOP** engine; engine is hot, allow it to cool sufficiently first; smoking.

Help prevent fires: fill gas tank to bottom of filler neck only; be sure fill cap is tight after fueling; clean up any gas spills

**IMMEDIATELY**; keep machine clean and in good repair - free of excess grease, oil, debris, and faulty or damaged parts; any storage of machines with gas left in tank should be in an area that is well ventilated to prevent possible igniting of fumes by an open flame or spark, this includes any appliance with a pilot light. To prevent fire or explosion caused by **STATIC ELECTRIC DISCHARGE** during fueling: **ONLY** use a clean, approved **POLYETHYLENE PLASTIC** fuel container and funnel **WITHOUT** any metal screen or filter.

#### To avoid engine damage:

- DO NOT mix oil with gasoline;
- **ONLY** use clean, fresh unleaded gasoline with an octane rating (anti-knock index) of 87 or higher;
- fill gas tank at the end of each day's operation to help prevent condensation from forming inside a partially filled tank;
- keep up with specified service intervals.

Use of alternative oxygenated, gasohol blended, unleaded gasoline is acceptable as long as:

- the ethyl or grain alcohol blends **DO NOT** exceed 10% by volume or
- methyl tertiary butyl ether (MTBE) blends **DO NOT** exceed 15% by volume

RFG (reformulated) gasoline is acceptable for all machines designed for use of regular unleaded fuel. Older machines (that were designed for leaded fuel) may see some accelerated valve and seat wear.



MIF



**IMPORTANT: Avoid damage! California Proposition 65 Warning: Gasoline engine exhaust from this product contains chemicals known to the State of California to cause cancer, birth defects, or other reproductive harm.**

## Gasoline Storage

**IMPORTANT: Avoid damage! Keep all dirt, scale, water or other foreign material out of gasoline.**

Keep gasoline stored in a safe, protected area. Storage of gasoline in a clean, properly marked ("UNLEADED GASOLINE") POLYETHYLENE PLASTIC container WITHOUT any metal screen or filter is recommended. DO NOT use de-icers to attempt to remove water from gasoline or depend on fuel filters to remove water from gasoline. Use a water separator installed in the storage tank outlet. BE SURE to properly discard unstable or contaminated gasoline. When storing the machine or gasoline, it is recommended that you add **John Deere Gasoline Conditioner and Stabilizer (TY15977)** or an equivalent to the gasoline. BE SURE to follow directions on container and to properly discard empty container.

## 4 - Cycle Gasoline Engine Oil

Use the appropriate oil viscosity based on the expected air temperature during the period between recommended oil changes. Operating outside of these recommended oil air temperature ranges may cause premature engine failure.

The following John Deere oils are **PREFERRED**:

- **PLUS - 4® - SAE 10W-40;**
- **TORQ - GARD SUPREME® - SAE 5W-30.**

The following John Deere oils are **also recommended**, based on their specified temperature range:

- **TURF - GARD® - SAE 10W-30;**
- **PLUS - 4® - SAE 10W-30;**
- **TORQ - GARD SUPREME® - SAE 30.**

Other oils may be used if above John Deere oils are not available, provided they meet one of the following specifications:

- SAE 10W-40 - API Service Classifications SG or higher;
- SAE 5W-30 - API Service Classification SG or higher;
- SAE 10W-30 - API Service Classifications SG or higher;
- SAE 30 - API Service Classification SC or higher.

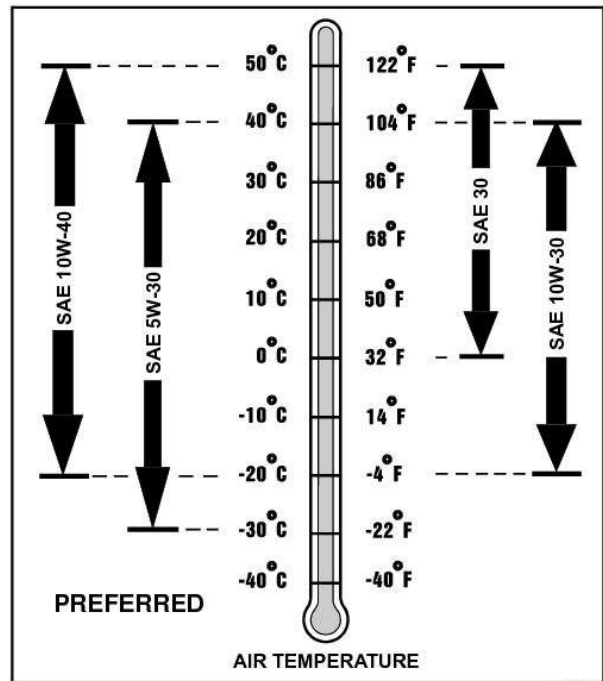

MIF

## Break-In Engine Oil - 4-Cycle Gasoline

**IMPORTANT: Avoid damage! ONLY use a quality break-in oil in rebuilt or remanufactured engines for the first 5 hours (maximum) of operation. DO NOT use oils with heavier viscosity weights than SAE 5W-30 or oils meeting specifications API SG or SH, these oils will not allow rebuilt or remanufactured engines to break-in properly.**

The following John Deere oil is **PREFERRED**:

- **BREAK - IN ENGINE OIL.**

John Deere BREAK - IN ENGINE OIL is formulated with special additives for aluminum and cast iron type engines to allow the power cylinder components (pistons, rings, and liners as well) to "wear-in" while protecting other engine components, valve train and gears, from abnormal wear. Engine rebuild instructions should be followed closely to determine if special requirements are necessary.

John Deere BREAK - IN ENGINE OIL is also recommended for non-John Deere engines, both aluminum and cast iron types.

The following John Deere oil is **also recommended**:

- **TORQ - GARD SUPREME® - SAE 5W-30.**

If the above recommended John Deere oils are not available, use a break-in engine oil meeting the following specification during the first **5 hours (maximum)** of operation:

- SAE 5W-30 - API Service Classification SE or higher.

**IMPORTANT: Avoid damage! After the break-in period, use the John Deere oil that is recommended for this engine.**

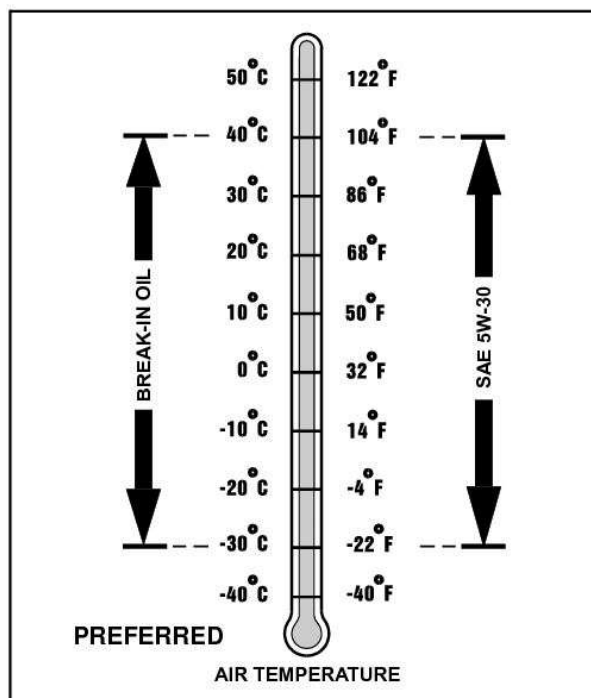

MIF

## Hydrostatic Transmission and Hydraulic Oil

Use the appropriate oil viscosity based on these air temperature ranges. Operating outside of these recommended oil air temperature ranges may cause premature hydrostatic transmission or hydraulic system failures.

**IMPORTANT: Avoid damage! Mixing of LOW VISCOSITY HY - GARD® and HY - GARD® oils is permitted. DO NOT mix any other oils in this transmission. DO NOT use engine oil or "Type F" (Red) Automatic Transmission Fluid in this transmission. DO NOT use BIO-HY-GARD® in this transmission.**

The following John Deere transmission and hydraulic oil is **PREFERRED**:

- **LOW VISCOSITY HY-GARD® - JDM J20D.**

The following John Deere oil is also recommended if above preferred oil is not available:

- **HY-GARD® - JDM J20C.**

Other oils may be used if above recommended John Deere oils are not available, provided they meet one of the following specifications:

- John Deere Standard JDM J20D;
- John Deere Standard JDM J20C.

# SPECIFICATIONS & INFORMATION GENERAL INFORMATION

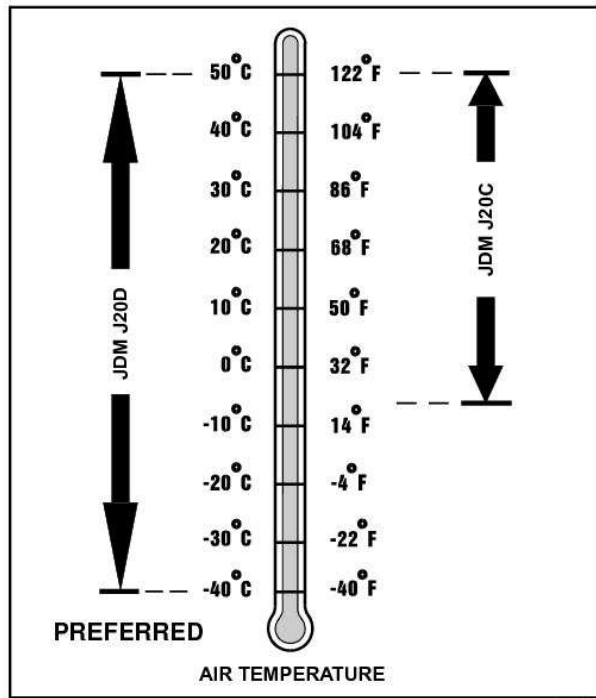

MIF

## Gear Case Oil

Use the appropriate oil viscosity based on the air temperature ranges. Operating outside of these recommended oil air temperature ranges may cause premature gear case failure.

**IMPORTANT: Avoid damage! ONLY use a quality oil in this gear case. DO NOT mix any other oils in this gear case. DO NOT use BIO-HY-GARD® in this gear case.**

The following John Deere gear case oil is **PREFERRED**:

- **GL-5 GEAR LUBRICANT® - SAE 80W-90.**

The following John Deere gear case oil is also recommended if above preferred oil is not available:

- **GL-5 GEAR LUBRICANT® - SAE 85W-140.**

Other gear case oils may be used if above recommended John Deere gear case oils are not available, provided they meet the following specification:

- API Service Classification GL - 5.

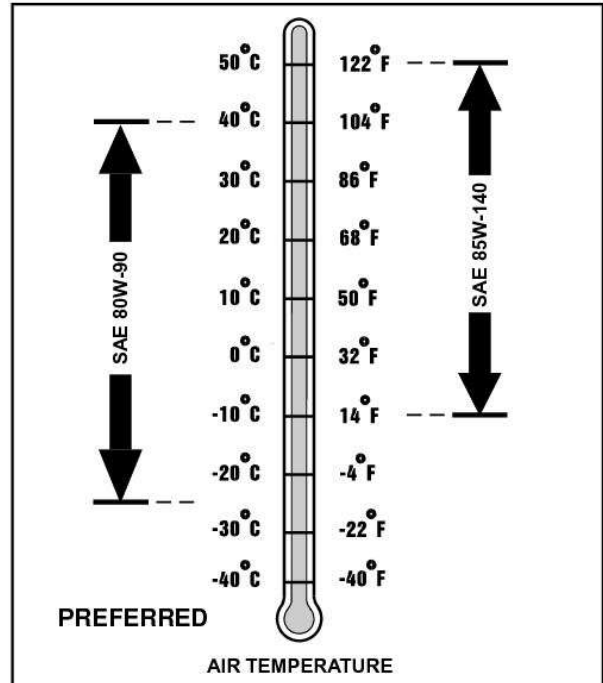

MIF

## Gear Transmission Grease

Use the following gear grease based on the air temperature range. Operating outside of the recommended grease air temperature range may cause premature gear transmission failure.

**IMPORTANT: Avoid damage! ONLY use a quality gear grease in this transmission. DO NOT mix any other greases in this transmission. DO NOT use any BIO - GREASE in this transmission.**

The following John Deere gear grease is PREFERRED:

- **NON-CLAY HIGH-TEMPERATURE EP GREASE®** - JDM J13E4, NLGI Grade 2.

Other greases may be used if above preferred John Deere grease is not available, provided they meet the following specification:

- John Deere Standard JDM J13E4, NLGI Grade 2.

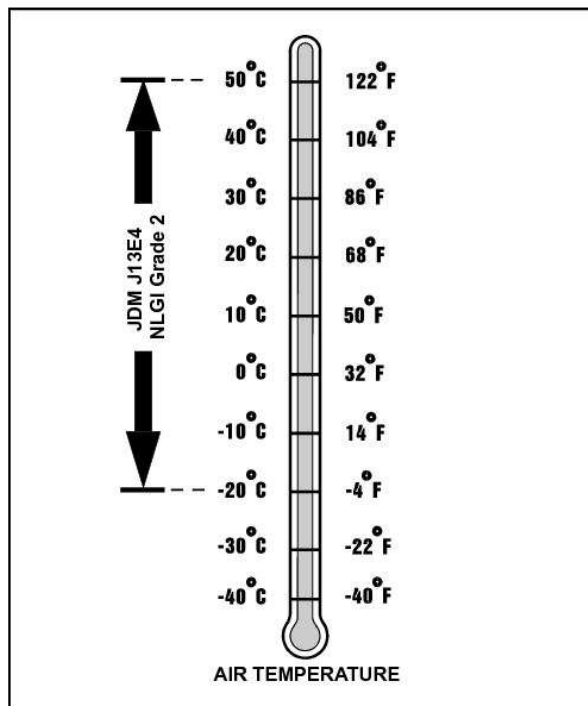

MIF

## Alternative Lubricants

Use of alternative lubricants could cause reduced life of the component.

If alternative lubricants are to be used, it is recommended that the factory fill be thoroughly removed before switching to any alternative lubricant.

## Synthetic Lubricants

Synthetic lubricants may be used in John Deere equipment if they meet the applicable performance requirements (industry classification and/or military specification) as shown in this manual.

The recommended air temperature limits and service or lubricant change intervals should be maintained as shown in the operator's manual, unless otherwise stated on lubricant label.

Avoid mixing different brands, grades, or types of oil. Oil manufacturers blend additives in their oils to meet certain specifications and performance requirements. Mixing different oils can interfere with the proper functioning of these additives and degrade lubricant performance.

## Lubricant Storage

All machines operate at top efficiency only when clean lubricants are used. Use clean storage containers to handle all lubricants. Store them in an area protected from dust, moisture, and other contamination. Store drums on their sides. Make sure all containers are properly marked as to their contents. Dispose of all old, used containers and their contents properly.

## Mixing of Lubricants

In general, avoid mixing different brands or types of lubricants. Manufacturers blend additives in their lubricants to meet certain specifications and performance requirements. Mixing different lubricants can interfere with the proper functioning of these additives and lubricant properties which will downgrade their intended specified performance.

## Oil Filters

**IMPORTANT: Avoid damage! Filtration of oils is critical to proper lubrication performance. Always change filters regularly.**

The following John Deere oil filters are PREFERRED:

- AUTOMOTIVE AND LIGHT TRUCK ENGINE OIL FILTERS.

Most John Deere filters contain pressure relief and anti-drainback valves for better engine protection.

Other oil filters may be used if above recommended John Deere oil filters are not available, provided they meet the following specification:

- ASTB Tested In Accordance With SAE J806.

## Coolant Specifications

### Gasoline Engine Coolant

The engine cooling system when filled with a proper dilution mixture of anti-freeze and deionized or distilled water provides year-round protection against corrosion, cylinder or liner pitting, and winter freeze protection down to **-37°C (-34°F)**.

The following John Deere coolant is **PREFERRED**:

- **COOL-GARD® PRE-DILUTED SUMMER COOLANT (TY16036)**.

This coolant satisfies specifications for "Automobile and Light Duty Engine Service" and is safe for use in John Deere Lawn and Grounds Care/Golf and Turf Division equipment, including aluminum block gasoline engines and cooling systems.

The above preferred pre-diluted anti-freeze provides:

- adequate heat transfer
- corrosion-resistant chemicals for the cooling system
- compatibility with cooling system hose and seal material
- protection during extreme cold and extreme hot weather operations
- chemically pure water for better service life
- compliance with ASTM D4656 (JDM H24C2) specifications

If above preferred pre-diluted coolant is not available, the following John Deere concentrate is recommended:

- **COOL-GARD® CONCENTRATED SUMMER COOLANT CONCENTRATE™ (TY16034)**.

If either of above recommended engine coolants are available use any Automobile and Light Duty Engine Service ethylene glycol base coolant, meeting the following specification:

- ASTM D4985 (JDM H24A2).

Read container label completely before using and follow instructions as stated.

**IMPORTANT: Avoid damage! To prevent engine damage, DO NOT use pure anti-freeze or less than a 50% anti-freeze mixture in the cooling system. DO NOT mix or add any additives/conditioners to the cooling system in Lawn and Grounds Care/Golf and Turf Division equipment. Water used to dilute engine coolant concentrate must be of high quality - clean, clear, potable water (low in chloride and hardness - Table 1) is generally acceptable. DO NOT use salt water. Deionized or distilled water is ideal to use. Coolant that is not mixed to these specified levels and water purity can cause excessive scale, sludge deposits, and increased corrosion potential.**

Property	Requirements
Total Solids, Maximum	340 ppm (20 grns/gal)
Total Hardness, Maximum	170 ppm (10 grns/gal)
Chloride (as Cl), Maximum	40 ppm (2.5 grns/gal)
Sulfate (as SO <sub>4</sub> ), Maximum	100 ppm (5.8 grns/gal)

Mix 50 percent anti-freeze concentrate with 50 percent distilled or deionized water. This mixture and the pre-diluted mixture (TY16036) will protect the cooling system down to **-37°C (-34°F)** and up to **108°C (226°F)**.

Certain geographical areas may require lower air temperature protection. See the label on your anti-freeze container or consult your John Deere dealer to obtain the latest information and recommendations.

### Gasoline Engine Coolant Drain Interval

When using John Deere Pre-Diluted (TY16036) Automobile and Light Duty Engine Service coolants, drain and flush the cooling system and refill with fresh coolant mixture every 36 months or 3,000 hours of operation, whichever comes first.

When using John Deere Concentrate (TY16034) Automobile and Light Duty Engine Service coolants, drain and flush the cooling system and refill with fresh coolant mixture every 24 months or 2,000 hours of operation, whichever comes first.

If above John Deere Automobile and Light Duty Engine Service coolants are not being used; drain, flush, and refill the cooling system according to instructions found on product container or in equipment operator's manual or technical manual.

## Serial Number Locations

### Product Serial Number



M55444

The 13-digit product identification number (A) is located on the right-hand side frame, just below engine compartment.

### Gasoline Engine Serial Number Location



MX13637

Engine serial number (A) is located on the valve cover.



# ENGINE - KOHLER TABLE OF CONTENTS

## Table of Contents

<b>Specifications</b> .....	<b>23</b>	Oil Pickup Inspection .....	52
General Specifications .....	23	Oil Pump Relief Valve Inspection .....	52
Tests and Adjustments Specifications.....	23	Oil Pump Installation.....	52
Repair Specifications.....	24	Camshaft Removal and Installation .....	53
Torque Specifications (Alphabetical) .....	27	Camshaft Inspection .....	53
Special or Required Tools .....	28	Camshaft End Play Measurement .....	54
Other Materials.....	28	Hydraulic Valve Lifters	
<b>Diagnostics</b> .....	<b>29</b>	Removal and Installation .....	54
Engine Will Start.....	29	Hydraulic Valve Lifters Inspection .....	55
<b>Tests and Adjustments</b> .....	<b>30</b>	Balancer Shaft	
Throttle Cable Adjustment.....	30	Removal and Installation .....	55
Choke Cable Adjustment.....	30	Balancer Shaft Inspection.....	56
Governor Adjustment .....	31	Governor Removal and Installation .....	56
Fast Idle Speed Adjustment .....	31	Governor Inspection .....	57
Slow Idle Screw Adjustment.....	31	Piston Assembly Removal.....	57
Cylinder Leak Test .....	32	Piston Assembly Disassemble .....	58
Automatic Compression Release		Piston Inspection .....	58
(ACR) Check .....	34	Piston Ring End Gap Measurement.....	58
Crankcase Vacuum Test.....	35	Piston Ring Side	
Fuel Flow Tests .....	36	Clearance Measurement .....	59
Oil Pressure Test.....	37	Piston Assembly Measurement.....	59
<b>Fuel and Air Repair</b> .....	<b>39</b>	Piston Assembly .....	60
Air Intake System Components .....	39	Piston Installation.....	61
Carburetor Removal and Installation.....	39	Crankshaft Removal and Installation.....	62
Carburetor Inspection.....	40	Crankshaft and	
Fuel Pump Removal and Installation.....	41	Main Bearing Inspection .....	62
<b>Engine Repair</b> .....	<b>42</b>	Crankshaft Alignment .....	63
Engine Removal and Installation.....	42	Cylinder Block	
Flywheel Removal and Installation.....	44	Removal and Installation .....	63
Stator Removal and Installation .....	45	Cylinder Block Inspection .....	63
Rocker Arms Removal and Installation .....	45	Cylinder Bore Deglazing.....	64
Inspect Push Rod.....	46	Starting Motor .....	64
Cylinder Head Removal and Installation .....	46	Voltage Regulator/Rectifier.....	67
Valves and Springs			
Removal and Installation .....	47		
Cylinder Head Inspection .....	47		
Valves Inspection .....	49		
Valve Seats Recondition .....	49		
Lap Valves .....	50		
Breather Inspection .....	50		
Oil Pan Removal and Installation .....	50		
Oil Pan Seal Removal and Installation .....	51		
Crankcase Oil Seal			
Removal and Installation.....	51		

**ENGINE - KOHLER TABLE OF CONTENTS**

---

---



# ENGINE - KOHLER SPECIFICATIONS

## Specifications

### General Specifications

Make.....	Kohler
Model Number.....	Command 15 QT / CV15S
Power.....	11.19 kW (15.0 hp)
Displacement.....	426 cm <sup>3</sup> (26.0 cu-in.)
Cylinders.....	1
Stroke/Cycle.....	4
Valves.....	Overhead Valves
Bore.....	90 mm (3.55 in.)
Stroke (All).....	67 mm (2.64 in.)
Compression Ratio.....	2:1 Cranking - 8.5:1 Running
Compression Release.....	Automatic/Centrifugal
Crankshaft Type.....	Vertical (Counterbalanced)
Lubrication.....	Pressurized Gerotor Pump, 0 - 413 kPa (0 - 60 psi)
Oil Filter.....	Single Element, Full Flow, Spin-On Filter
Crankcase Oil Capacity w/o Oil Filter).....	1.3 L (1.4 qt)
Crankcase Oil Capacity w/ Oil Filter.....	1.8 L (1.9 qt)
Cooling System.....	Air Cooled
Air Cleaner.....	Paper w/ Outer Foam Element
Muffler.....	Horizontal Discharge Below Frame
Maximum Angle of Operation (With Full Crankcase):	
Continuous (All Directions).....	.20°
Intermittent (All Directions).....	.35°
Fuel Filter.....	Replaceable (In-Line Type)
Fuel Shut-Off Solenoid.....	Replaceable (Below Carburetor Float Bowl)
Weight.....	39.5 kg (87 lbs)

### Tests and Adjustments Specifications

#### Engine:

Valve Adjustment.....	None (Hydraulic Lifters)
Oil Pressure (at 3350 rpm).....	69 - 517 kPa (10 - 75 psi)
(Minimum at 1250 rpm).....	28 kPa (4 psi)
Crankcase Vacuum (Minimum At Operating Temp.).....	102 mm (4.0 in.)
Automatic Compression Release Minimum Lift.....	0.76 - 1.02 mm (0.030 - 0.040 in.)
Ignition Module Air Gap.....	0.25 mm (0.010 in.)
Fuel/Air System:	
Carburetor Slow Idle Mixture Screw Initial Setting.....	Lightly Seat, Then 1 Turn Out
Fuel Pressure (Minimum).....	6.12 kPa (0.90 psi)
Fuel Flow (Minimum, 15 Seconds).....	30 ml (1.0 US oz)
Slow Idle Speed.....	1550 ± 100 rpm
Fast Idle Speed.....	3350 ± 50 rpm
Spark Plug Type.....	Champion RC12YC
Spark Plug Gap.....	1.0 mm (0.040 in.)
Torque.....	40 N·m (30 lb-ft)

# ENGINE - KOHLER SPECIFICATIONS

## Repair Specifications

### Cylinder Head

Cylinder Head Flatness (Maximum Warp) ..... 0.076 mm (0.003 in.)

### Push Rod

Maximum Bend ..... 0.76 mm (0.030 in.)

### Valves and Valve Lifters

Hydraulic Lifter Clearance ..... 0.0124 - 0.0501 mm (0.0005 - 0.0020 in.)

Intake Valve-to-Guide Clearance ..... 0.038 - 0.076 mm (0.0015 - 0.0030 in.)

Intake Valve Stem OD ..... 6.982 - 7.000 mm (0.275 - 0.276 in.)

Oversize ..... 7.232 - 7.250 mm (0.284 - 0.285 in.)

#### Intake Valve Guide ID:

New ..... 7.038 - 7.058 mm (0.277 - 0.278 in.)

Maximum ..... 7.134 mm (0.281 in.)

Oversize ..... 7.288 - 7.308 mm (0.287 - 0.288 in.)

Exhaust Valve-to-Guide Clearance ..... 0.050 - 0.088 mm (0.002 - 0.0035 in.)

Exhaust Valve Stem OD ..... 6.970 - 6.988 mm (0.274 - 0.275 in.)

Oversize ..... 7.220 - 7.238 mm (0.284 - 0.285 in.)

#### Exhaust Valve Guide ID:

New ..... 7.038 - 7.058 mm (0.277 - 0.278 in.)

Maximum ..... 7.159 mm (0.282 in.)

Oversize ..... 7.238 - 7.308 mm (0.285 - 0.288 in.)

#### Valve Guide Reamer:

Standard ..... 7.048 mm (0.2775 in.)

Oversize (0.25 mm) ..... 7.298 mm (0.2873 in.)

Intake Valve Lift (Minimum - Engine Cold) ..... 8.96 mm (0.353 in.)

Exhaust Valve Lift (Minimum - Engine Cold) ..... 9.14 mm (0.360 in.)

Valve Face Angle ..... 45°

Valve Seat Angle ..... 44.5°

Valve Margin (Minimum) ..... 1.5 mm (0.059 in.)

Valve Stem Bend (Maximum) ..... 0.076 mm (0.003 in.)

### Rocker Arms

#### Rocker Arm Bearing ID:

New ..... 15.837 - 16.127 mm (0.63 - 0.64 in.)

Wear Limit ..... 15.727 mm (0.619 in.)

### Rocker Shaft

#### Rocker Shaft OD:

New ..... 15.837 - 16.127 mm (0.63 - 0.64 in.)

Wear Limit ..... 15.727 mm (0.619 in.)

### Crankshaft

End Play ..... 0.0575 - 0.4925 mm (0.0023 - 0.0194 in.)

# ENGINE - KOHLER SPECIFICATIONS

---

**Crankshaft Bore ID (Crankcase Half):**

**New** ..... 44.965 - 45.003 mm (1.7703 - 1.7718 in.)  
**Maximum** ..... 45.016 mm (1.7723 in.)  
**(Clearance (New))** ..... 0.03 - 0.09 mm (0.0012 - 0.0035 in.)

**Crankshaft Bore (Oil Pan Half):**

**New** ..... 44.965 - 45.003 mm (1.7703 - 1.7718 in.)  
**Maximum** ..... 45.016 mm (1.7723 in.)  
**Clearance (New)** ..... 0.03 - 0.09 mm (0.0012 - 0.0035 in.)

**Main Bearing Journal OD (Flywheel End):**

**New** ..... 44.913 - 44.935 mm (1.7682 - 1.7691 in.)  
**Minimum** ..... 44.84 mm (1.765 in.)  
**Maximum Taper** ..... 0.022 mm (0.0009 in.)  
**Maximum Out-of-Round** ..... 0.025 mm (0.0010 in.)

**Main Bearing Journal OD (Oil Pan End):**

**New** ..... 41.915 - 41.935 mm (1.6502 - 1.6510 in.)  
**Minimum** ..... 41.86 mm (1.648 in.)  
**Maximum Taper** ..... 0.020 mm (0.0008 in.)  
**Maximum Out-of-Round** ..... 0.025 mm (0.0010 in.)

**Connecting Rod Journal OD:**

**New** ..... 38.958 - 38.970 mm (1.5338 - 1.5343 in.)  
**Minimum** ..... 38.94 mm (1.5328 in.)  
**Maximum Taper** ..... 0.012 mm (0.0005 in.)  
**Maximum Out-of-Round** ..... 0.025 mm (0.0010 in.)

**Crankshaft Total Indicated Runout (TIR):**

**PTO End (In Engine)** ..... 0.15 mm (0.0059 in.)  
**Entire Crankshaft (In Bench V-Blocks)** ..... 0.10 mm (0.0039 in.)

**Camshaft**

**End Play (with shims)** ..... 0.076 - 0.127 mm (0.003 - 0.005 in.)  
**Clearance** ..... 0.025 - 0.063 mm (0.0010 - 0.0025 in.)

**Bore ID:**

**New** ..... 20.000 - 20.025 mm (0.7874 - 0.7884 in.)  
**Maximum** ..... 20.038 mm (0.7889 in.)

**Bearing Journal OD:**

**New** ..... 19.962 - 19.975 mm (0.7859 - 0.7864 in.)  
**Minimum** ..... 19.959 mm (0.7858 in.)

**Balance Shaft**

**End Play** ..... 0.0575 - 0.3625 mm (0.0023 - 0.0143 in.)  
**Clearance** ..... 0.025 - 0.063 mm (0.0009 - 0.0025 in.)

**Bore ID:**

**New** ..... 20.000 - 20.025 mm (0.7874 - 0.7884 in.)  
**Maximum** ..... 20.038 mm (0.7889 in.)

**Balance Shaft Bearing Surface (Journal) OD:**

**New** ..... 19.962 - 19.975 mm (0.7859 - 7864 in.)  
**Minimum** ..... 19.959 mm (0.7858 in.)

# ENGINE - KOHLER SPECIFICATIONS

---

## Cylinder Bore, Piston and Rings

### Cylinder Bore ID:

New ..... 90.000 - 90.025 mm (3.5433 - 3.5443 in.)

Maximum ..... 90.63 mm (3.5681 in.)

Maximum Out-of-Round ..... 0.12 mm (0.0047 in.)

Maximum Taper ..... 0.05 mm (0.0020 in.)

Piston-to-Cylinder Clearance ..... 0.031 - 0.043 mm (0.0012 - 0.0016 in.)

Piston-To-Pin Clearance ..... 0.006 - 0.017 mm (0.0002 - 0.0007 in.)

### Piston Pin Bore ID:

New ..... 19.006 - 19.012 mm (0.7483 - 0.7485 in.)

Maximum ..... 19.025 mm (0.7490 in.)

### Piston Pin OD:

New ..... 18.995 - 19.000 mm (0.7478 - 0.7480 in.)

Minimum ..... 18.994 mm (0.7478 in.)

Top Compression Ring-To-Groove Side Clearance ..... 0.060 - 0.105 mm (0.0023 - 0.0041 in.)

Middle Compression Ring-To-Groove Side Clearance ..... 0.040 - 0.085 mm (0.0015 - 0.0002 in.)

Oil Control Ring-To-Groove Side Clearance ..... 0.176 - 0.026 mm (0.0069 - 0.0010 in.)

### Top and Center Compression Ring End Gap:

New Bore ..... 0.27 - 0.51 mm (0.010 - 0.020 in.)

Used Bore (Maximum) ..... 0.77 mm (0.030 in.)

### Piston Thrust Face OD:

New ..... 89.951 - 89.969 mm (3.5413 - 3.5420 in.)

Minimum ..... 89.824 mm (3.5363 in.)

### Piston Thrust Face-To-Cylinder Bore Clearance:

New ..... 0.031 - 0.043 mm (0.0012 - 0.0016 in.)

## Connecting Rod

### Crankshaft (Big End) Clearance:

New ..... 0.030 - 0.055 mm (0.0012 - 0.0022 in.)

Maximum ..... 0.07 mm (0.0025 in.)

Side ..... 0.18 - 0.41 mm (0.007 - 0.016 in.)

Piston Pin Clearance ..... 0.015 - 0.028 mm (0.0006 - 0.0011 in.)

### Piston Pin End ID:

New ..... 19.015 - 19.023 mm (0.7486 - 0.7489 in.)

Maximum ..... 19.036 mm (0.7495 in.)

## Governor

### Crankcase Control Arm Bore ID:

New ..... 6.025 - 6.050 mm (0.2372 - 0.2382 in.)

Maximum ..... 6.063 mm (0.2387 in.)

### Control Arm OD:

New ..... 5.975 - 6.000 mm (0.2352 - 0.2362 in.)

Minimum ..... 5.962 mm (0.2347 in.)

Crankcase Bore-To-Control Arm Clearance ..... 0.025 - 0.075 mm (0.0010 - 0.0030 in.)

### Gear Shaft OD:

New ..... 5.990 - 6.000 mm (0.2358 - 0.2362 in.)

Minimum ..... 5.977 mm (0.2353 in.)

Gear Shaft-To- Gear Bore Clearance ..... 0.015 - 0.140 mm (0.0006 - 0.0055 in.)

## Oil Pump

Relief Valve Spring Free Length ..... 25.19 mm (0.99 in.)

Oil Pump Cover-to-Rotor Clearance ..... 0.076 mm (0.003 in.)

# ENGINE - KOHLER SPECIFICATIONS

## Torque Specifications (Alphabetical)

*NOTE: Use appropriate torque wrench which will read within the inch pound range given, or convert inch pounds to foot pounds as follows: Inch-pounds  $\div$  12 = Foot-pounds*

Air Cleaner Base Nut	9.9 N•m (88 lb-in.)
Cylinder Head Cap Screw:	
Initial	20 N•m (177 lb-in.)
Final	41 N•m (30 lb-ft)
Connecting Rod Cap Screws:	
8 mm Straight Shank Bolt	22.7 N•m (200 lb-in.)
Step Down Shank Bolt	14.7 N•m (130 lb-in.)
6 mm Straight Shank Bolt	11.3 N•m (100 lb-in.)
Engine Mounting Cap Screws	32 N•m (24 lb-ft)
Fan Cap Screw	9.9 N•m (88 lb-in.)
Flywheel Cap Screw	68 N•m (50 lb-ft)
Fuel Pump/Cover Screw:	
New Installation (Thread Forming)	9.0 N•m (80 lb-in.)
Replacement	7.3 N•m (65 lb-in.)
Fuel Bowl Nut	4.0 N•m (35 lb-in.)
Governor Arm Clamp Nut	10 N•m (89 lb-in.)
Governor Control Panel Screw	9.9 N•m (88 lb-in.)
Ignition Module Screw:	
New Installation (Thread Forming)	6.2 N•m (55 lb-in.)
Replacement	4.0 N•m (35 lb-in.)
Muffler Nut	24.4 N•m (216 lb-in.)
Oil Filter	7.4 N•m (65 lb-in.)
Oil Filter Drain Plug	8.15 N•m (72.5 lb-in.)
Oil Pan Cap Screw	24.4 N•m (216 lb-in.)
Oil Pressure Switch	7.9 N•m (70 lb-in.)
Oil Pump Cover Screw:	
New Installation (Thread Forming)	6.2 N•m (55 lb-in.)
Replacement	4.0 N•m (35 lb-in.)
PTO Clutch to Engine Mounting Cap Screw	75 N•m (55 lb-ft)
Rocker Arm Pivot Cap Screw	14 N•m (124 lb-in.)
Spark Plug	40 N•m (30 lb-ft)
Starting Motor Mounting Cap Screws	24 N•m (216 lb-in.)
Stator Cap Screw	4.0 N•m (35 lb-in.)
Throttle Plate Cap Screw	10.7 N•m (95 lb-in.)
Valve Cover Cap Screw:	
New Installation (Thread Forming)	10.7 N•m (95 lb-in.)
Replacement	7.3 N•m (65 lb-in.)
Voltage Regulator/Rectifier	7.3 N•m (65 lb-in.)

# ENGINE - KOHLER SPECIFICATIONS

## Special or Required Tools

### Special or Required Tools

Tool Name	Tool No.	Tool Use
Reaming Tool (7.05 mm)	D20020WI	Used to clean or size valve guides
Reaming Tool (7.25 mm)	JDG705	Used to bore oversize valve guide
Valve Spring Compressor	JDM70	Used to remove and install valve springs
Drill Bit	6.4 mm (0.25 in.)	Throttle and choke adjustment
Dial Indicator		Automatic compression relief test, valve inspection, crankshaft end play
Digital Pulse Tachometer	JT07270	Slow and/or fast idle adjustment
Photo Tachometer	JT05719	Slow and/or fast idle adjustment
Spark Plug Ground	JDM74A5	Used to prevent accidental engine starting during tests
Cylinder Leak Tester	JT035029	Cylinder leak test
U-Tube Manometer Test Kit; or, Crankcase Vacuum Test Kit	JT05697 JT03503	Crankcase vacuum check
Oil Pressure Test Adapter w/ O-ring (required only on engines without test ports)	JT07262	Oil pressure test
Connector	JT05487	
Hose Assembly	JT03017	
Coupler	JT03262	
Gauge, 0 - 700 kPa (0 - 100 psi)	JT07034	
Lapping Tool		Valve lapping

## Other Materials

### Other Material

Part No.	Part Name	Part Use
M79292	MPG-2® Multipurpose Grease	Apply to engine crankshaft
	SCOTCH-BRITE® Abrasive Sheets/Pads	Clean cylinder head
	Valve Guide Cleaner	Clean valve guides
	Lithium Base Grease	Pack oil seals
	Mineral Spirits	Clean armature
	Valve Lap Compound	Lap valves
TY15130 / 395	LOCTITE® Form-in-Place Gasket	Rocker arm cover mating surfaces

MPG-2® is a registered trademark of DuBois USA

SCOTCH-BRITE® is a registered trademark of the 3M Co.

LOCTITE® is a registered trademark of the Loctite Corp.



# ENGINE - KOHLER DIAGNOSTICS

## Diagnostics

### Engine Will Start



**CAUTION: Avoid Injury! BE AWARE!** The engine may start to rotate at any time. Keep hands away from all moving parts when testing.

**NOTE: To test specific electrical components, see Electrical section and refer to either Diagnostics or Tests and Adjustments for further guidance.**

#### Symptom: Engine Will Not Crank

**(1) Is battery voltage 12.4 volts or higher?**

**Yes** - Go to next step 3.

**No** - Charge battery and perform no-load test. Go to next step.

**(2) Is battery voltage 12.4 volts or higher?**

**Yes** - Go to next step.

**No** - Replace battery.

**(3) Does starter solenoid click when ignition switch is turned to START position?**

**Yes** - Check starter motor.

**No** - Check electrical system.



**CAUTION: Avoid Injury! DO NOT** rotate engine with starter if the spark plugs are removed. Gasoline spray from the open cylinders may be ignited by ignition spark and cause an explosion or fire.

**NOTE: Perform a visual inspection first to determine if battery cables are tight and not corroded and if battery is of sufficient size to turn the engine over at minimum cranking speed of 350 rpm.**

#### Symptom: Engine Cranks But Will Not Start

**(1) Is battery voltage 12.4 volts or higher?**

**Yes** - Go to next step 3.

**No** - Charge battery and perform no-load test. Go to next step.

**(2) Is battery voltage 12.4 volts or higher?**

**Yes** - Go to next step.

**No** - Replace battery.

#### Symptom: Engine Cranks But Will Not Start

**(3) Does fuel shutoff solenoid click when ignition switch is turned to START/RUN?**

**Yes** - Go to next step.

**No** - Defective fuel shutoff solenoid, switch or wiring. See Electrical section.

**(4) Does engine crank slow?**

**Yes** - Remove spark plugs and turn the engine over by hand. Go to next step.

**No** - Go to step 6.

**(5) Is the engine hard to turn over by hand?**

**Yes** - Pistons or other internal components binding.

**No** - Starter motor defective. Repair or replace as needed.

**(6) Is the choke operating properly?**

**Yes** - Go to next step.

**No** - Adjust choke cable. See "Choke Cable Adjustment" on page 30.

**(7) Do spark plugs have strong blue spark?**

**Yes** - Go to next step.

**No** - Possible defective spark plugs, magneto shorted to ground, flywheel magnet weak, or ignition coil air gap not adjusted. See Electrical section.

**(8) Are tappets adjusted properly.**

**Yes** - Go to next step.

**No** - Adjust. See "Cylinder Leak Test" on page 32.

**(9) Is engine getting fuel?**

**Yes** - Check air leaner, fuel mixture, contaminated fuel, or possible stuck float needle.

**No** - Check fuel shutoff valve, fuel lines, fuel pump, and engine vacuum. See "Fuel Flow Tests" on page 36, or "Crankcase Vacuum Test" on page 35.

# ENGINE - KOHLER TESTS AND ADJUSTMENTS

## Tests and Adjustments

### Throttle Cable Adjustment

#### Reason:

To make sure the throttle cable moves the throttle and choke control lever through its full range of movement.

#### Equipment:

- JT05719 Photo Tachometer; or,
- JT07270 Digital Pulse Tachometer

#### Procedure:

1. Start and run engine at MEDIUM idle for 5 minutes.
2. Loosen cable clamp (A) securing throttle cable.

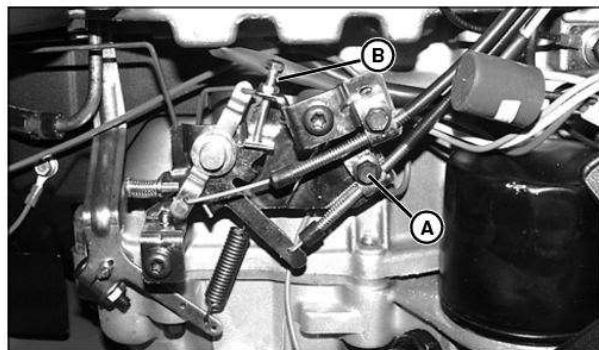

M99723

3. Place throttle lever in fast idle position.
4. Adjust fast idle screw (B) until fast idle is  $3350 \pm 50$  rpm. Pull throttle cable housing rearward to remove any slack in throttle cable.
5. Tighten throttle cable clamp.

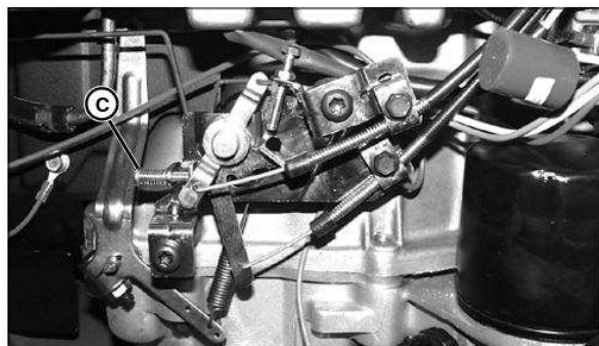

M99722

6. Move throttle lever to the slow position.
7. Adjust slow idle screw (C) to set low idle at  $1550 \pm 100$  rpm.
8. Move throttle lever through full range to be sure linkage is not binding.

### Choke Cable Adjustment

#### Reason:

To make sure the choke plate is fully closed when the choke lever is in the full choke position. Correct adjustment also ensures choke is completely open when the choke lever is in the OFF (choke open) position.

#### Procedure:

1. Stop engine and set parking brake.
2. Remove air cleaner assembly from carburetor.
3. Move choke lever to full CHOKE position.

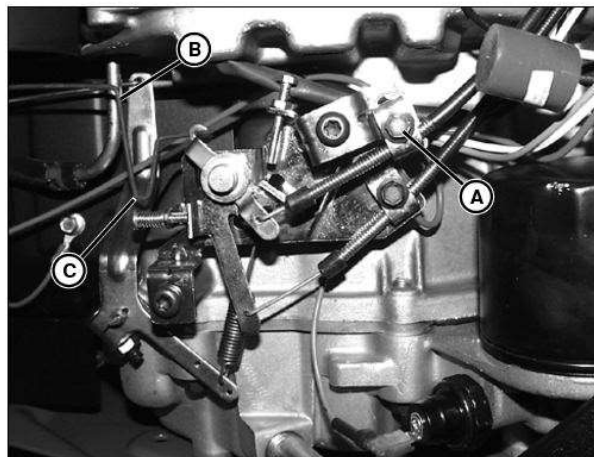

M99724

4. Loosen choke cable clamp (A) and pull cable housing rearward to remove any slack in choke cable.
5. Tighten choke cable clamp.
6. Move throttle lever to full choke position.
7. Try to move choke rod (B) forward (choke rod should not move). If the choke rod moves forward, the choke plate is not fully closed. Carefully bend the choke rod at Vee bend (C) until the choke plate is fully closed.
8. Move choke lever to be sure choke linkage is not binding and choke plate fully opens when choke lever is in the OFF position.

# [John Deere LX255 LX266 LX277 Service Manual](#)



Maintenance

Engine

Control System

Mechanical

Fuel Service Specifications

Emission Control

Intake Exhaust Cooling

Lube

Ignition Starting Charging

Auto Transmission Clutch

Manual Transmission

Transfer Propeller Shaft

The manual provides detailed instructions on tasks such as checking fluid levels, inspecting key components, and performing basic troubleshooting. Following these guidelines not only extends the life of the equipment but also prevents costly breakdowns.

**[John Deere LX255 LX266 LX277 Service Manual](#)**

# ENGINE - KOHLER TESTS AND ADJUSTMENTS

## Governor Adjustment

### Reason:

To make sure the governor shaft contacts the fly-weight plunger when the engine is stopped.

**NOTE: Adjust throttle cable before adjusting governor linkage.**

### Procedure:

1. Move throttle lever to FAST idle position.

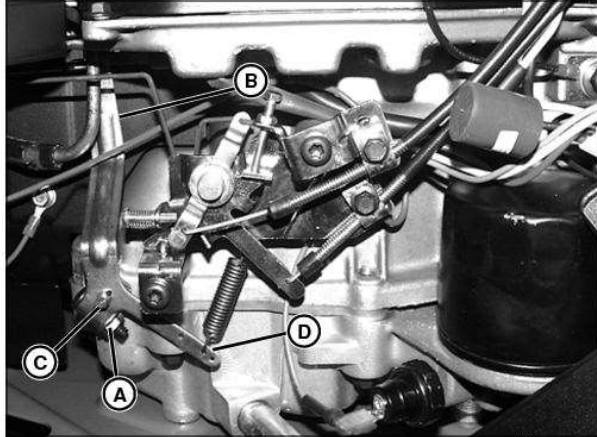

2. Loosen nut (A).
3. Hold top of governor arm (B) toward carburetor. Turn governor shaft (C) counter-clockwise until it stops. Hold governor shaft and tighten nut.
4. Move throttle lever through full range to be sure linkage is not binding.
5. If governor is not responding properly, check that governor spring is in correct hole (D) in governor arm, replace spring and readjust fast idle speed. If spring did not correct the problem, repair governor.

## Fast Idle Speed Adjustment

### Reason:

To set engine fast idle rpm.

### Equipment:

- JT05719 Photo Tachometer; or,
- JT07270 Digital Pulse Tachometer

### Procedure:

1. Move transaxle shift lever to NEUTRAL position. Lock park brake.



**CAUTION: Avoid injury! Engine will be HOT. Be careful not to burn skin.**

2. Start and run engine at MEDIUM idle for 5 minutes.
3. Loosen cable clamp (A) securing throttle cable.

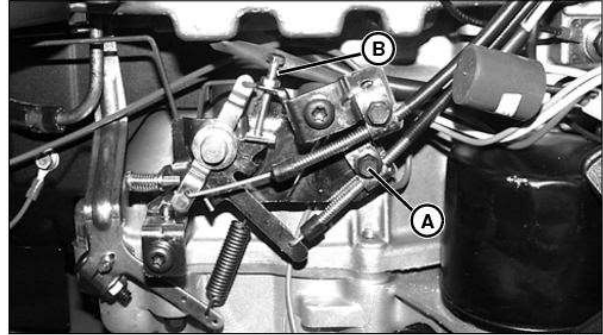

4. Place throttle lever in fast idle position.
5. Adjust fast idle screw (B) until fast idle is  $3350 \pm 50$  rpm. Pull throttle cable housing rearward to remove any slack in throttle cable.
6. Tighten throttle cable clamp.
7. Use a photo tachometer to check engine rpm at the blower housing screen; or, use a digital pulse tachometer to check engine rpm at spark plug wire.

### Specifications:

**Fast Idle Speed Setting . . . . .  $3350 \pm 50$  rpm**

## Slow Idle Screw Adjustment

### Reason:

To set engine slow idle stop screw. Slow idle is governed.

### Equipment:

- JT05719 Photo Tachometer; or,
- JT07270 Digital Pulse Tachometer

### Procedure:

1. Move transaxle to NEUTRAL. Lock park brake.

**IMPORTANT: Avoid damage! DO NOT remove air cleaner for tests**

2. Put reflective tape on blower housing screen if using a photo tachometer.
3. No preliminary adjustment is required for carburetor limiter slow idle mixture screw, this is pre-set by manufacturer.