

**JOHN DEERE**  
**WORLDWIDE COMMERCIAL & CONSUMER**  
**EQUIPMENT DIVISION**

---

**Garden Tractors**  
**GX255, GX325, GX335 and GX345**

TM1973 FEBRUARY 2005

**TECHNICAL MANUAL**



**JOHN DEERE**

North American Version  
Litho in U.S.A.



# INTRODUCTION

## Manual Description

This technical manual is written for an experienced technician and contains sections that are specifically for this product. It is a part of a total product support program.

The manual is organized so that all the information on a particular system is kept together. The order of grouping is as follows:

- Table of Contents
- Specifications and Information
- Identification Numbers
- Tools and Materials
- Component Location
- Schematics and Harnesses
- Theory of Operation
- Operation and Diagnostics
- Diagnostics
- Tests and Adjustments
- Repair
- Other

**NOTE: Depending on the particular section or system being covered, not all of the above groups may be used.**

The bleed tabs for the pages of each section will align with the sections listed on this page. Page numbering is consecutive from the beginning of the Safety section through the last section.

We appreciate your input on this manual. If you find any errors or want to comment on the layout of the manual please contact us.

All information, illustrations and specifications in this manual are based on the latest information at the time of publication. The right is reserved to make changes at any time without notice.

COPYRIGHT© 2005  
Deere & Co.  
John Deere Worldwide Commercial and  
Consumer Equipment Division  
All rights reserved  
Previous Editions  
COPYRIGHT© 2001, 2003

Safety

Specifications and Information

Engine—325 (FH531V)

Engine—255/335 (FH601V)

Engine—345 (FD611V)

Electrical

Power Train-Hydrostatic

Hydraulics

Steering—255

Steering—325

Steering—335/345

Brakes

Attachments

Miscellaneous



# SAFETY

## Recognize Safety Information

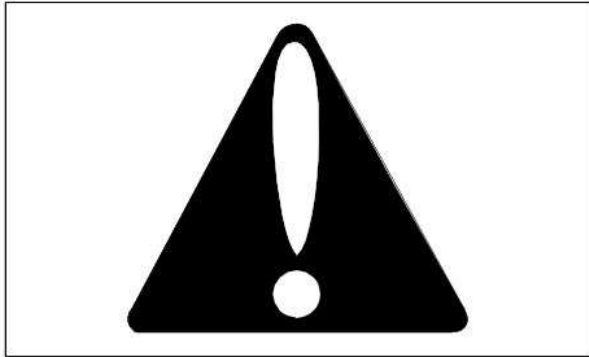

MIF

This is the safety-alert symbol. When you see this symbol on your machine or in this manual, be alert to the potential for personal injury.

Follow recommended precautions and safe servicing practices.

## Understand Signal Words

A signal word - DANGER, WARNING, or CAUTION - is used with the safety-alert symbol. DANGER identifies the most serious hazards.

DANGER or WARNING safety signs are located near specific hazards. General precautions are listed on CAUTION safety signs. CAUTION also calls attention to safety messages in this manual.

## Replace Safety Signs

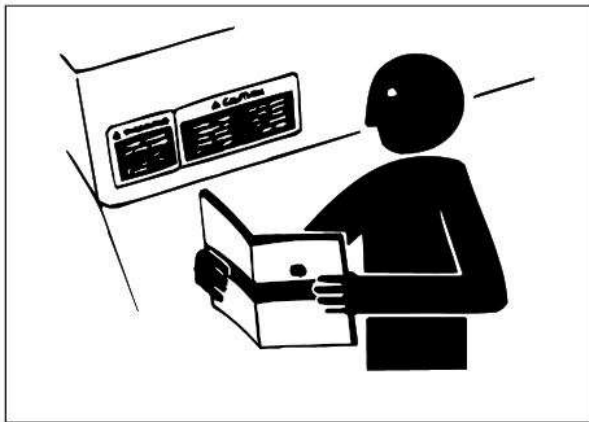

MIF

Replace missing or damaged safety signs. See the machine operator's manual for correct safety sign placement.

## Handle Fluids Safely - Avoid Fires

### Be Prepared For Emergencies

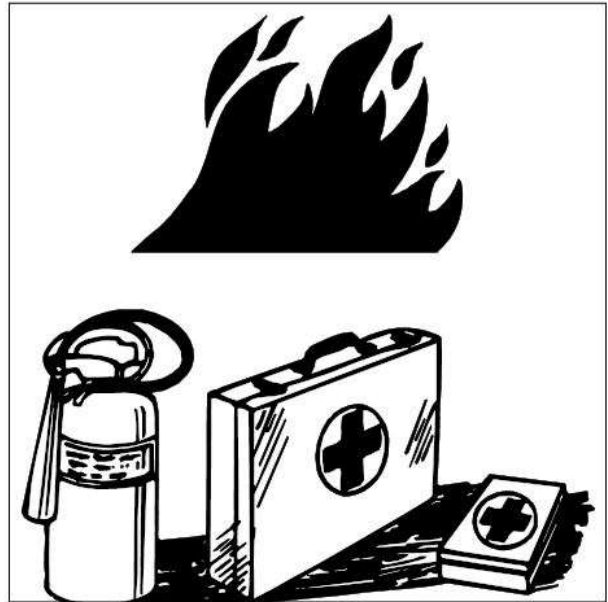

MIF

- When you work around fuel, do not smoke or work near heaters or other fire hazards.
- Store flammable fluids away from fire hazards. Do not incinerate or puncture pressurized containers.
- Make sure machine is clean of trash, grease, and debris.
- Do not store oily rags; they can ignite and burn spontaneously.
- Be prepared if a fire starts.
- Keep a first aid kit and fire extinguisher handy.
- Keep emergency numbers for doctors, ambulance service, hospital, and fire department near your telephone.

## Use Care In Handling and Servicing Batteries

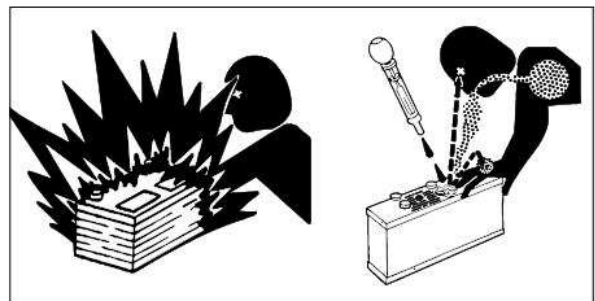

MIF

# SAFETY

## Prevent Battery Explosions

- Keep sparks, lighted matches, and open flame away from the top of battery. Battery gas can explode.
- Never check battery charge by placing a metal object across the posts. Use a volt-meter or hydrometer.
- Do not charge a frozen battery; it may explode. Warm battery to 16°C (60°F).

## Prevent Acid Burns

- Sulfuric acid in battery electrolyte is poisonous. It is strong enough to burn skin, eat holes in clothing, and cause blindness if splashed into eyes.

### Avoid acid burns by:

1. Filling batteries in a well-ventilated area.
2. Wearing eye protection and rubber gloves.
3. Avoiding breathing fumes when electrolyte is added.
4. Avoiding spilling or dripping electrolyte.
5. Use proper jump start procedure.

### If you spill acid on yourself:

1. Flush your skin with water.
2. Apply baking soda or lime to help neutralize the acid.
3. Flush your eyes with water for 10 - 15 minutes.
4. Get medical attention immediately.

### If acid is swallowed:

1. Drink large amounts of water or milk.
2. Then drink milk of magnesia, beaten eggs, or vegetable oil.
3. Get medical attention immediately.

## Wear Protective Clothing

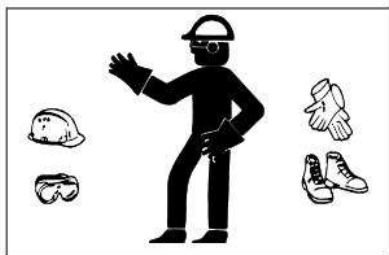

MIF

Wear close fitting clothing and safety equipment appropriate to the job.

Prolonged exposure to loud noise can cause impairment or loss of hearing. Wear a suitable hearing protective device

such as earmuffs or earplugs to protect against objectionable or uncomfortable loud noises.

Operating equipment safely requires the full attention of the operator. Do not wear radio or music headphones while operating machine.

## Use Care Around High-Pressure Fluid Lines

### Avoid High-Pressure Fluids



MIF

Escaping fluid under pressure can penetrate the skin causing serious injury.

Avoid injury from escaping fluid under pressure by stopping the engine and relieving pressure in the system before disconnecting or connecting hydraulic or other lines. Tighten all connections before applying pressure.

Search for leaks with a piece of cardboard. Protect hands and body from high pressure fluids.

If an accident occurs, see a doctor immediately. Any fluid injected into the skin must be surgically removed within a few hours or gangrene may result. Doctors unfamiliar with this type of injury should reference a knowledgeable medical source. Such information is available from Deere & Company Medical Department in Moline, Illinois, U.S.A.

### Avoid Heating Near Pressurized Fluid Lines



MIF

Flammable spray can be generated by heating near pressurized fluid lines, resulting in severe burns to yourself and bystanders. Do not heat by welding, soldering, or using a torch near pressurized fluid lines or other flammable materials. Pressurized lines can be accidentally cut when heat goes beyond the immediate flame area.

# SAFETY

## Service Machines Safely

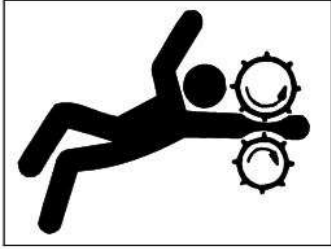

MIF

Tie long hair behind your head. Do not wear a necktie, scarf, loose clothing, or necklace when you work near machine tools or moving parts. If these items were to get caught, severe injury could result.

Remove rings and other jewelry to prevent electrical shorts and entanglement in moving parts.

## Use Proper Tools

Use tools appropriate to the work. Makeshift tools and procedures can create safety hazards. Use power tools only to loosen threaded parts and fasteners. For loosening and tightening hardware, use the correct size tools. **DO NOT** use U.S. measurement tools on metric fasteners. Avoid bodily injury caused by slipping wrenches. Use only service parts meeting John Deere specifications.

## Park Machine Safely

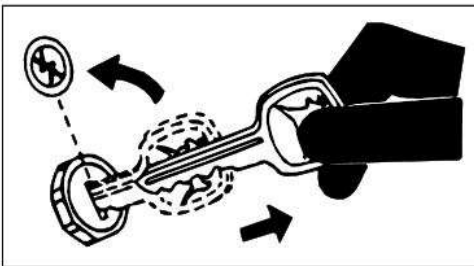

MIF

### Before working on the machine:

1. Lower all equipment to the ground.
2. Stop the engine and remove the key.
3. Disconnect the battery ground strap.
4. Hang a "DO NOT OPERATE" tag in operator station.

## Using 120 Volt Electric Outlet System Safely

- 120 Volt electric outlet system is an on-board high-voltage generator. Failure to observe all safety messages may result in property damage, injury or death.
- Do not use 120 Volt electric outlet system as a backup for a main power source, such as in a house that is powered by a utility company. Doing so may cause a power backfeed that could electrocute utility workers or others who contact power lines.
- Do not use 120 Volt electric outlet system in an enclosed area. Engine gives off carbon monoxide. Breathing carbon monoxide can cause illness, unconsciousness or death.
- Do not use 120 Volt electric outlet system in wet conditions.
- Do not use 120 Volt electric outlet system if it does not pass all safety system tests.
- A ground fault occurs when, instead of following its normal safe path, electricity passes through a person's body to the ground. Ground fault circuit interrupter (GFCI) shuts off power to receptacle if it detects a ground fault.
- GFCI receptacle protects against ground faults. It does not protect against current overloads, short circuits or shocks.
- Do not use 120 Volt electric outlet system if electric power is lost and cannot be restored by resetting GFCI or 120 Volt electric outlet system.
- Do not use 120 Volt electric outlet system with hood open.
- Do not modify 120 Volt electric outlet system in any way.
- Perform only service functions described in this manual. For all other service, see a John Deere dealer.
- Use only John Deere approved replacement parts.
- Do not connect a battery charger to 120 Volt electric outlet system. Connecting this way may damage certain types of battery chargers.

# SAFETY

## Support Machine Properly and Use Proper Lifting Equipment



MIF

If you must work on a lifted machine or attachment, securely support the machine or attachment.

Do not support the machine on cinder blocks, hollow tiles, or props that may crumble under continuous load. Do not work under a machine that is supported solely by a jack. Follow recommended procedures in this manual.

Lifting heavy components incorrectly can cause severe injury or machine damage. Follow recommended procedure for removal and installation of components in the manual.

## Work In Clean Area

### Before starting a job:

1. Clean work area and machine.
2. Make sure you have all necessary tools to do your job.
3. Have the right parts on hand.
4. Read all instructions thoroughly; do not attempt shortcuts.

## Using High Pressure Washers

Directing pressurized water at electronic/electrical components or connectors, bearings, hydraulic seals, fuel injection pumps or other sensitive parts and components may cause product malfunctions. Reduce pressure and spray at a 45 to 90 degree angle.

## Illuminate Work Area Safely

Illuminate your work area adequately but safely. Use a portable safety light for working inside or under the machine. Make sure the bulb is enclosed by a wire cage. The hot filament of an accidentally broken bulb can ignite spilled fuel or oil.

## Work In Ventilated Area

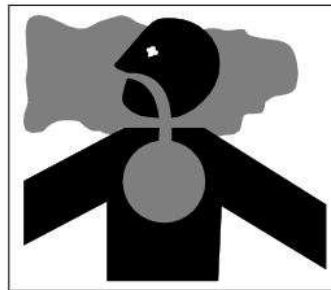

MIF

Engine exhaust fumes can cause sickness or death. If it is necessary to run an engine in an enclosed area, remove the exhaust fumes from the area with an exhaust pipe extension.

If you do not have an exhaust pipe extension, open the doors and get outside air into the area.

## Warning: California Proposition 65 Warning

Gasoline engine exhaust from this product contains chemicals known to the State of California to cause cancer, birth defects, or other reproductive harm.

Diesel engine exhaust and some of its constituents are known to the State of California to cause cancer, birth defects, and other reproductive harm.

## Remove Paint Before Welding or Heating

Avoid potentially toxic fumes and dust. Hazardous fumes can be generated when paint is heated by welding, soldering, or using a torch. Do all work outside or in a well ventilated area. Dispose of paint and solvent properly. Remove paint before welding or heating: If you sand or grind paint, avoid breathing the dust. Wear an approved respirator. If you use solvent or paint stripper, remove stripper with soap and water before welding. Remove solvent or paint stripper containers and other flammable material from area. Allow fumes to disperse at least 15 minutes before welding or heating.

## Avoid Harmful Asbestos Dust

Avoid breathing dust that may be generated when handling components containing asbestos fibers. Inhaled asbestos fibers may cause lung cancer.

Components in products that may contain asbestos fibers are brake pads, brake band and lining assemblies, clutch plates, and some gaskets. The asbestos used in these components is usually found in a resin or sealed in some way. Normal handling is not hazardous as long as airborne dust containing asbestos is not generated.



# SAFETY

Avoid creating dust. Never use compressed air for cleaning. Avoid brushing or grinding material containing asbestos. When servicing, wear an approved respirator. A special vacuum cleaner is recommended to clean asbestos. If not available, apply a mist of oil or water on the material containing asbestos. Keep bystanders away from the area.

## Service Tires Safely



MIF

Explosive separation of a tire and rim parts can cause serious injury or death.

Do not attempt to mount a tire unless you have the proper equipment and experience to perform the job.

Always maintain the correct tire pressure. Do not inflate the tires above the recommended pressure. Never weld or heat a wheel and tire assembly. The heat can cause an increase in air pressure resulting in a tire explosion. Welding can structurally weaken or deform the wheel.

When inflating tires, use a clip-on chuck and extension hose long enough to allow you to stand to one side and NOT in front of or over the tire assembly. Use a safety cage if available.

Check wheels for low pressure, cuts, bubbles, damaged rims or missing lug bolts and nuts.

## Avoid Injury From Rotating Blades, Augers and PTO Shafts

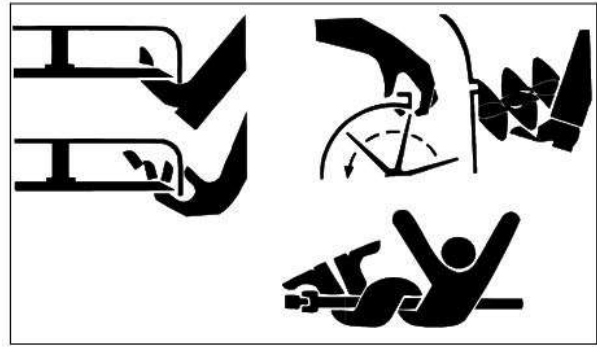

MIF

Keep hands and feet away while machine is running. Shut off power to service, lubricate or remove mower blades, augers or PTO shafts.

## Service Cooling System Safely

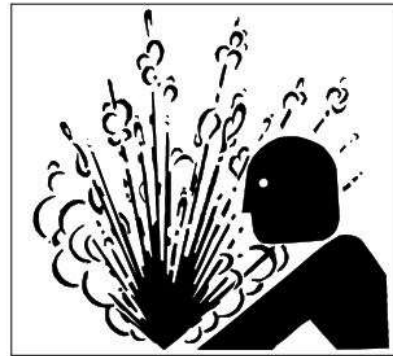

MIF

Explosive release of fluids from pressurized cooling system can cause serious burns.

Shut off machine. Only remove filler cap when cool enough to touch with bare hands. Slowly loosen cap to first stop to relieve pressure before removing completely.

# SAFETY

## Handle Chemical Products Safely

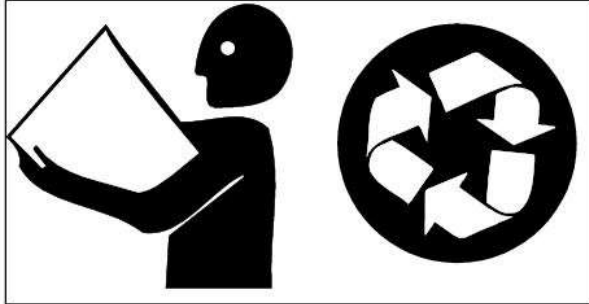

MIF

Direct exposure to hazardous chemicals can cause serious injury. Potentially hazardous chemicals used with John Deere equipment include such items as lubricants, coolants, paints, and adhesives.

A Material Safety Data Sheet (MSDS) provides specific details on chemical products: physical and health hazards, safety procedures, and emergency response techniques. Check the MSDS before you start any job using a hazardous chemical. That way you will know exactly what the risks are and how to do the job safely. Then follow procedures and recommended equipment.

## Dispose of Waste Properly

Improperly disposing of waste can threaten the environment and ecology. Potentially harmful waste used with John Deere equipment include such items as oil, fuel, coolant, brake fluid, filters, and batteries. Use leakproof containers when draining fluids. Do not use food or beverage containers that may mislead someone into drinking from them. Do not pour waste onto the ground, down a drain, or into any water source. Inquire on the proper way to recycle or dispose of waste from your local environmental or recycling center, or from your John Deere dealer.

## Live With Safety



MIF

Before returning machine to customer, make sure machine is functioning properly, especially the safety systems. Install all guards and shields.

# SPECIFICATIONS & INFORMATION TABLE OF CONTENTS

---

## Table of Contents

<b>Fastener Torques</b> .....	<b>9</b>
Metric Fastener Torque Values .....	9
Inch Fastener Torque Values .....	10
<b>General Information</b> .....	<b>11</b>
Gasoline .....	11
Gasoline Storage.....	11
Engine Oil - North America.....	12
Engine Oil - Europe .....	12
Engine Break - In Oil .....	12
Hydrostatic Transmission Oil.....	13
Anti-Corrosion Grease .....	13
Alternative Lubricants.....	13
Synthetic Lubricants .....	13
Lubricant Storage .....	14
Mixing Of Lubricants.....	14
Chassis Grease.....	14
Oil Filters .....	14
<b>Serial Number Locations</b> .....	<b>15</b>
Product Identification Number (PIN).....	15
Engine Identification Number - FH531V/ FH601V .....	15
Engine Identification Number - FD611V.....	15
Carburetor Identification Number - FH531V.	15
Carburetor Identification Number - FH601V.	15
Carburetor Identification Number - FD611V.	16
Hydrostatic Transaxle Identification Number .....	16





# SPECIFICATIONS & INFORMATION FASTENER TORQUES

## Fastener Torques

### Metric Fastener Torque Values

Property Class and Head Markings				
Property Class and Nut Markings				

MIF

SIZE	Class 4.8				Class 8.8 or 9.8				Class 10.9				Class 12.9			
	Lubricated a		Dry a		Lubricated a		Dry a		Lubricated a		Dry a		Lubricated a		Dry a	
	N•m	lb-ft	N•m	lb-ft	N•m	lb-ft	N•m	lb-ft	N•m	lb-ft	N•m	lb-ft	N•m	lb-ft	N•m	lb-ft
M6	4.8	3.5	6	4.5	9	6.5	11	8.5	13	9.5	17	12	15	11.5	19	14.5
M8	12	8.5	15	11	22	16	28	20	32	24	40	30	37	28	47	35
M10	23	17	29	21	43	32	55	40	63	47	80	60	75	55	95	70
M12	40	29	50	37	75	55	95	70	110	80	140	105	130	95	165	120
M14	63	47	80	60	120	88	150	110	175	130	225	165	205	150	260	109
M16	100	73	125	92	190	140	240	175	275	200	350	225	320	240	400	300
M18	135	100	175	125	260	195	330	250	375	275	475	350	440	325	560	410
M20	190	140	240	180	375	275	475	350	530	400	675	500	625	460	800	580
M22	260	190	330	250	510	375	650	475	725	540	925	675	850	625	1075	800
M24	330	250	425	310	650	475	825	600	925	675	1150	850	1075	800	1350	1000
M27	490	360	625	450	950	700	1200	875	1350	1000	1700	1250	1600	1150	2000	1500
M30	675	490	850	625	1300	950	1650	1200	1850	1350	2300	1700	2150	1600	2700	2000
M33	900	675	1150	850	1750	1300	2200	1650	2500	1850	3150	2350	2900	2150	3700	2750
M36	1150	850	1450	1075	2250	1650	2850	2100	3200	2350	4050	3000	3750	2750	4750	3500

DO NOT use these hand torque values if a different torque value or tightening procedure is given for a specific application. Torque values listed are for general use only and include a  $\pm 10\%$  variance factor. Check tightness of fasteners periodically. DO NOT use air powered wrenches.

Shear bolts are designed to fail under predetermined loads. Always replace shear bolts with identical grade.

Fasteners should be replaced with the same grade. Make sure fastener threads are clean and that you properly start thread engagement. This will prevent them from failing when tightening.

When bolt and nut combination fasteners are used, torque values should be applied to the NUT instead of the bolt head.









Tighten toothed or serrated-type locknuts to the full torque value.

a "Lubricated" means coated with a lubricant such as engine oil, or fasteners with phosphate and oil coatings. "Dry" means plain or zinc plated (yellow dichromate - Specification JDS117) without any lubrication.

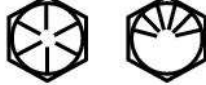
Reference: JDS - G200.

# SPECIFICATIONS & INFORMATION FASTENER TORQUES

## Inch Fastener Torque Values

SAE Grade and Head Markings	1 or 2 <sup>b</sup> No Marks 	5    5.1    5.2 	8    8.2 
SAE Grade and Nut Markings	2 No Marks 	5  	8  

MIF

SIZE	Grade 1		Grade 2b				Grade 5, 5.1 or 5.2				Grade 8 or 8.2					
	Lubricated a		Dry a		Lubricated a		Dry a		Lubricated a		Dry a		Lubricated a		Dry a	
	N•m	lb-ft	N•m	lb-ft	N•m	lb-ft	N•m	lb-ft	N•m	lb-ft	N•m	lb-ft	N•m	lb-ft	N•m	lb-ft
1/4	3.7	2.8	4.7	3.5	6	4.5	7.5	5.5	9.5	7	12	9	13.5	10	17	12.5
5/16	7.7	5.5	10	7	12	9	15	11	20	15	25	18	28	21	35	26
3/8	14	10	17	13	22	16	27	20	35	26	44	33	50	36	63	46
7/16	22	16	28	20	35	26	44	32	55	41	70	52	80	58	100	75
1/2	33	25	42	31	53	39	67	50	85	63	110	80	120	90	150	115
9/16	48	36	60	45	75	56	95	70	125	90	155	115	175	130	225	160
5/8	67	50	85	62	105	78	135	100	170	125	215	160	215	160	300	225
3/4	120	87	150	110	190	140	240	175	300	225	375	280	425	310	550	400
7/8	190	140	240	175	190	140	240	175	490	360	625	450	700	500	875	650
1	290	210	360	270	290	210	360	270	725	540	925	675	1050	750	1300	975
1-1/8	470	300	510	375	470	300	510	375	900	675	1150	850	1450	1075	1850	1350
1-1/4	570	425	725	530	570	425	725	530	1300	950	1650	1200	2050	1500	2600	1950
1-3/8	750	550	950	700	750	550	950	700	1700	1250	2150	1550	2700	2000	3400	2550
1-1/2	1000	725	1250	925	990	725	1250	930	2250	1650	2850	2100	3600	2650	4550	3350

DO NOT use these hand torque values if a different torque value or tightening procedure is given for a specific application. Torque values listed are for general use only and include a ±10% variance factor. Check tightness of fasteners periodically. DO NOT use air powered wrenches.

Shear bolts are designed to fail under predetermined loads. Always replace shear bolts with identical grade.

Fasteners should be replaced with the same grade. Make sure fastener threads are clean and that you properly start thread engagement. This will prevent them from failing when tightening.

When bolt and nut combination fasteners are used, torque values should be applied to the NUT instead of the bolt

head.

Tighten toothed or serrated-type locknuts to the full torque value.

a "Lubricated" means coated with a lubricant such as engine oil, or fasteners with phosphate and oil coatings. "Dry" means plain or zinc plated (yellow dichromate - Specification JDS117) without any lubrication.

b "Grade 2" applies for hex cap screws (Not Hex Bolts) up to 152 mm (6 in.) long. "Grade 1" applies for hex cap screws over 152 mm (6 in.) long, and for all other types of bolts and screws of any length.

Reference: JDS - G200

## General Information

### Gasoline

#### 4 - Cycle Engines



**CAUTION: Avoid Injury! Gasoline is HIGHLY FLAMMABLE, handle it with care. DO NOT refuel machine while: indoors, always fill gas tank outdoors; machine is near an open flame or sparks; engine is running, STOP engine; engine is hot, allow it to cool sufficiently first; smoking.**

**Help prevent fires: fill gas tank to bottom of filler neck only; be sure fill cap is tight after fueling; clean up any gas spills IMMEDIATELY; keep machine clean and in good repair - free of excess grease, oil, debris, and faulty or damaged parts; any storage of machines with gas left in tank should be in an area that is well ventilated to prevent possible igniting of fumes by an open flame or spark, this includes any appliance with a pilot light. To prevent fire or explosion caused by STATIC ELECTRIC DISCHARGE during fueling: •ONLY use a clean, approved POLYETHYLENE PLASTIC fuel container and funnel WITHOUT any metal screen or filter.**

#### To avoid engine damage:

- DO NOT mix oil with gasoline;
- **ONLY use clean, fresh unleaded gasoline with an octane rating (anti-knock index) of 87 or higher;**
- Fill gas tank at the end of each day's operation to help prevent condensation from forming inside a partially filled tank;
- Keep up with specified service intervals.

Use of alternative oxygenated, gasohol blended, unleaded gasoline is acceptable as long as:

- The ethyl or grain alcohol blends DO NOT exceed 10% by volume or
- Methyl tertiary butyl ether (MTBE) blends DO NOT exceed 15% by volume

RFG (reformulated) gasoline is acceptable for all machines designed for use of regular unleaded fuel. Older machines (that were designed for leaded fuel) may see some accelerated valve and seat wear.



MIF



**CAUTION: Avoid Injury! California Proposition 65 Warning: Gasoline engine exhaust from this product contains chemicals known to the State of California to cause cancer, birth defects, or other reproductive harm.**

### Gasoline Storage

**IMPORTANT: Avoid damage! Keep all dirt, scale, water or other foreign material out of gasoline.**

Keep gasoline stored in a safe, protected area. Storage of gasoline in a clean, properly marked ("UNLEADED GASOLINE") POLYETHYLENE PLASTIC container WITHOUT any metal screen or filter is recommended. DO NOT use de-icers to attempt to remove water from gasoline or depend on fuel filters to remove water from gasoline. Use a water separator installed in the storage tank outlet. BE SURE to properly discard unstable or contaminated gasoline. When storing the machine or gasoline, it is recommended that you add **John Deere Gasoline Conditioner and Stabilizer (TY15977)** or an equivalent to the gasoline. BE SURE to follow directions on container and to properly discard empty container.

# SPECIFICATIONS & INFORMATION GENERAL INFORMATION

## Engine Oil - North America

Use the appropriate oil viscosity based on the expected air temperature range during the period between recommended oil changes. Operating outside of these recommended oil air temperature ranges may cause premature engine failure.

The following John Deere oil is **PREFERRED**:

- **TORQ-GARD SUPREME® - SAE 5W-30.**

The following John Deere oils are **also recommended**, based on their specified temperature range:

- **TURF-GARD® - SAE 10W-30;**
- **PLUS-4® - SAE 10W-30;**
- **TORQ-GARD SUPREME® - SAE 30.**

Other oils may be used if above John Deere oils are not available, provided they meet one of the following specifications:

- SAE 5W-30 - API Service Classification SG or higher;
- SAE 10W-30 - API Service Classification SG or higher;
- SAE 30 - API Service Classification SC or higher.

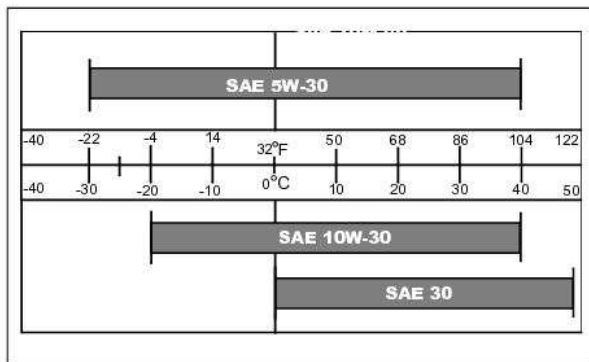

## Engine Oil - Europe

Use the appropriate oil viscosity based on their expected air temperature range during the period between recommended oil changes. Operating outside of these recommended oil air temperature ranges may cause premature engine failure.

The following John Deere oils are **PREFERRED**:

- **TORQ-GARD SUPREME® - SAE 5W-30;**
- **UNI-GARD™ - SAE 5W-30.**

The following John Deere oils are **also recommended**, based on their specified temperature range:

- **TORQ-GARD SUPREME® - SAE 10W-30;**
- **UNI-GARD™ - SAE 10W-30;**

- **TORQ-GARD SUPREME® - SAE 30**
- **UNI-GARD™ - SAE 30.**

Other oils may be used if above John Deere oils are not available, provided they meet one of the following specifications:

- CCMC Specification G4 or higher.

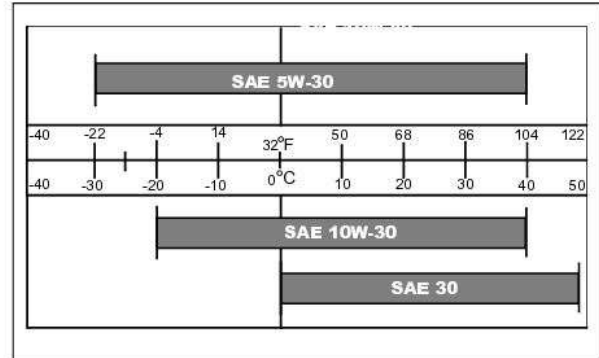

## Engine Break - In Oil

**IMPORTANT: Avoid damage! ONLY use a quality break-in oil in rebuilt or remanufactured engines for the first 5 hours (maximum) of operation. DO NOT use oils with heavier viscosity weights than SAE 5W-30 or oils meeting specifications API SG or SH, these oils will not allow rebuilt or remanufactured engines to break-in properly.**

The following John Deere oil is **PREFERRED**:

- John Deere **BREAK-IN ENGINE OIL.**

John Deere BREAK-IN ENGINE OIL is formulated with special additives for aluminum and cast iron type engines to allow the power cylinder components (pistons, rings, and liners as well) to “wear-in” while protecting other engine components, valve train and gears, from abnormal wear. Engine rebuild instructions should be followed closely to determine if special requirements are necessary.

John Deere BREAK-IN ENGINE OIL is also recommended for non-John Deere engines, both aluminum and cast iron types.

The following John Deere oil is **also recommended as a break-in engine oil**:

- **TORQ-GARD SUPREME® - SAE 5W-30.**

If the above recommended John Deere oils are not available, use a break-in engine oil meeting the following specification during the first 5 hours (maximum) of operation:

- SAE 5W-30 - API Service Classification SE or higher.



# SPECIFICATIONS & INFORMATION GENERAL INFORMATION

- SAE 5W-30 - CCMC Specification G4 or higher.

**IMPORTANT: Avoid damage! After the break-in period, use the John Deere oil that is recommended for this engine.**

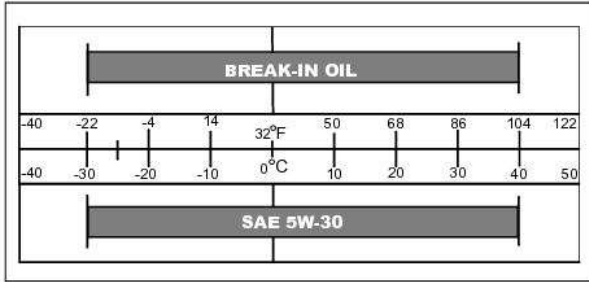

## Hydrostatic Transmission Oil

Use the appropriate oil viscosity based on these air temperature ranges. Operating outside of these recommended oil air temperature ranges may cause premature hydrostatic transmission or hydraulic system failures.

**IMPORTANT: Avoid damage! Use only the oils recommended. HY-GARD® - JDM J20C can be mixed with 5W30 or 10W30 in this application. Use LOW VISCOSITY HY - GARD® oil.**

The following John Deere oil is **PREFERRED**:

- **HY-GARD® - JDM J20C.**

The following John Deere transmission oil is also recommended if above preferred oil is not available:

- **5W30 or 10W30.**

Other oils may be used if above recommended John Deere oils are not available, provided they meet one of the following specifications:

- John Deere Standard JDM J20C.

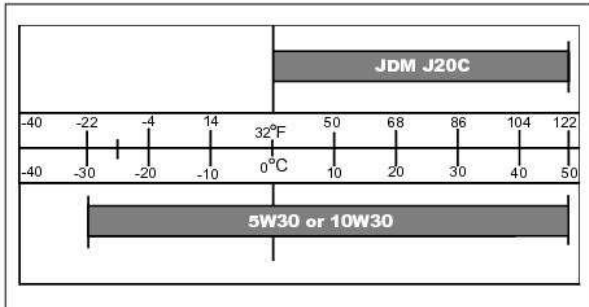

Use only oils that meet the following specifications:

- API Service Classifications SG or higher.
- CCMC Specifications G4 or higher.

## Anti-Corrosion Grease

This anti-corrosion grease is formulated to provide the best protection against absorbing moisture, which is one of the major causes of corrosion. This grease is also superior in its resistance to separation and migration.

The following anti-corrosion grease is **PREFERRED**:

- DuBois MPG-2® Multi-Purpose Polymer Grease - M79292.

Other greases may be used if they meet or exceed the following specifications:

- John Deere Standard JDM J13A2, NLGI Grade 1.

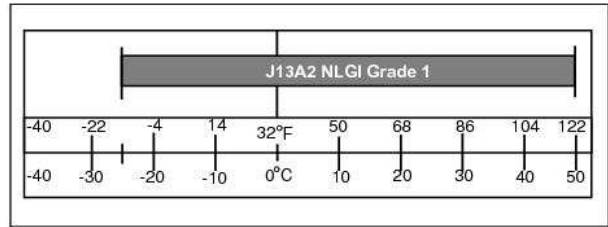

## Alternative Lubricants

Conditions in certain geographical areas outside the United States and Canada may require different lubricant recommendations than the ones printed in this technical manual or the operator's manual. Consult with your John Deere Dealer, or Sales Branch, to obtain the alternative lubricant recommendations.

**IMPORTANT: Avoid damage! Use of alternative lubricants could cause reduced life of the component.**

If alternative lubricants are to be used, it is recommended that the factory fill be thoroughly removed before switching to any alternative lubricant.

## Synthetic Lubricants

Synthetic lubricants may be used in John Deere equipment if they meet the applicable performance requirements (industry classification and/or military specification) as shown in this manual.

The recommended air temperature limits and service or lubricant change intervals should be maintained as shown in the operator's manual.

Avoid mixing different brands, grades, or types of oil. Oil manufacturers blend additives in their oils to meet certain

# SPECIFICATIONS & INFORMATION GENERAL INFORMATION

specifications and performance requirements. Mixing different oils can interfere with the proper functioning of these additives and degrade lubricant performance.

## Lubricant Storage

All machines operate at top efficiency only when clean lubricants are used. Use clean storage containers to handle all lubricants. Store them in an area protected from dust, moisture, and other contamination. Store drums on their sides. Make sure all containers are properly marked as to their contents. Dispose of all old, used containers and their contents properly.

## Mixing Of Lubricants

In general, avoid mixing different brands or types of lubricants. Manufacturers blend additives in their lubricants to meet certain specifications and performance requirements. Mixing different lubricants can interfere with the proper functioning of these additives and lubricant properties which will downgrade their intended specified performance.

## Chassis Grease

Use the following grease based on the air temperature range. Operating outside of the recommended grease air temperature range may cause premature failures.

**IMPORTANT: Avoid damage! ONLY use a quality grease in this application. DO NOT mix any other greases in this application. DO NOT use any BIO-GREASE in this application.**

The following John Deere grease is PREFERRED:

- **HIGH-TEMPERATURE EP GREASE® - JDM J13E4, NLGI Grade 2.**
- **GREASE-GARD™ - JDM J13E4, NLGI Grade 2.**

Other greases may be used if above preferred John Deere grease is not available, provided they meet the following specification:

- John Deere Standard JDM J13E4, NLGI Grade 2.

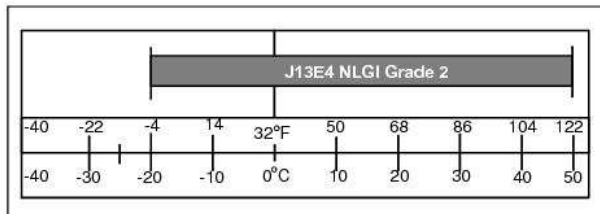

## Oil Filters

**IMPORTANT: Avoid damage! Filtration of oils is critical to proper lubrication performance. Always change filters regularly.**

The following John Deere oil filters are PREFERRED:

- Automotive And Light Truck Engine Oil Filters.

Most John Deere filters contain pressure relief and anti-drainback valves for better engine protection.

Other oil filters may be used if above recommended John Deere oil filters are not available, provided they meet the following specification:

- ASTB Tested In Accordance With SAE J806.

# SPECIFICATIONS & INFORMATION SERIAL NUMBER LOCATIONS

## Serial Number Locations

### Product Identification Number (PIN)

When ordering parts or submitting a warranty claim, it is **IMPORTANT** that you include the product identification number and the component product identification numbers.

The location of identification numbers and component product identification numbers are shown.



M82994

### Engine Identification Number - FH531V/ FH601V



M95470

### Engine Identification Number - FD611V

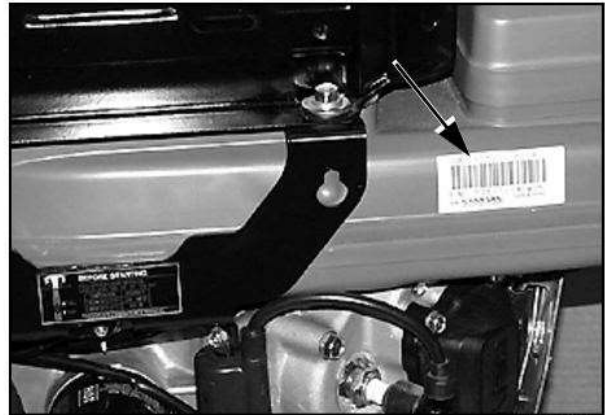

M95471

### Carburetor Identification Number - FH531V

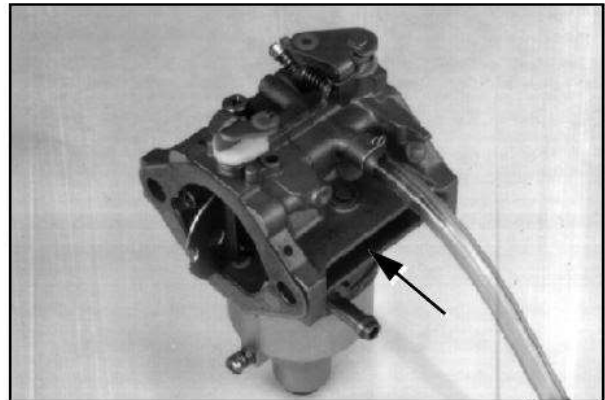

M82830

### Carburetor Identification Number - FH601V

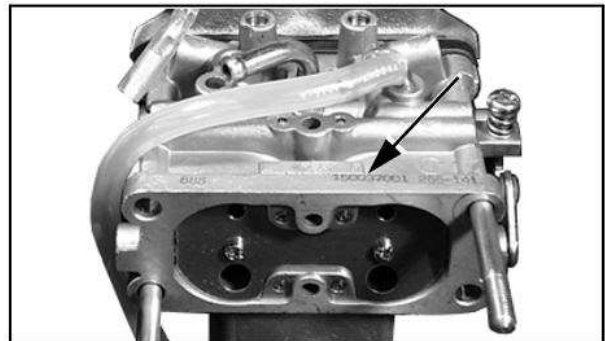

M99822A

**SPECIFICATIONS & INFORMATION SERIAL NUMBER LOCATIONS**

**Carburetor Identification Number - FD611V**

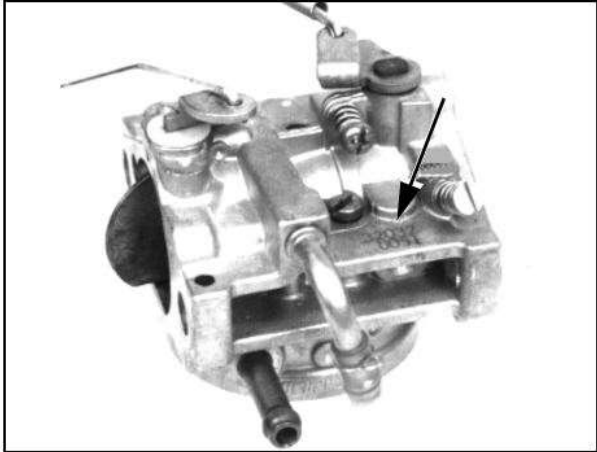

M53957A

**Hydrostatic Transaxle Identification Number**

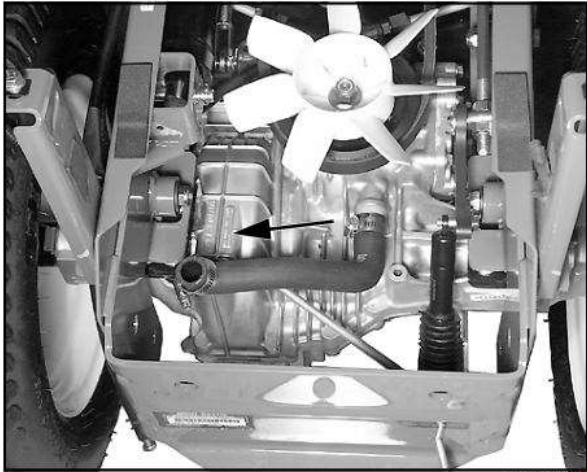

MX9617

# ENGINE - KAWASAKI (FH531V) TABLE OF CONTENTS

<b>Table of Contents</b>	Lap Valves .....	48
	Crankcase Cover Removal and Installation.	49
	Piston and Connecting Rod.....	49
	Analyze Crankshaft and Connecting Rod	
	Wear .....	54
	Camshaft and Tappets .....	54
	Crankshaft and Main Bearings .....	55
	Crankshaft Oil Seals.....	57
	Deglaze Cylinder Bore.....	57
	Resize Cylinder Bore .....	57
	Oil Pump Disassembly and Assembly .....	58
	Oil Filter Manifold.....	60
	Governor Inspection and Replacement .....	60
	Governor Shaft Inspection and	
	Replacement.....	60
	Stator Removal and Installation.....	61
	Armature Removal and Installation.....	61
	Starting Motor .....	62
	Starting Motor Disassembly and Assembly .	62
	No-Load Amperage Draw and RPM Test....	64
<b>Specifications</b> .....		<b>19</b>
General Specifications .....		19
Tests and Adjustment Specifications .....		19
Repair Specifications.....		20
Torque Specifications.....		21
<b>Tools and Materials</b> .....		<b>22</b>
Tools.....		22
Other Materials.....		23
Service Parts Kits .....		23
<b>Component Location</b> .....		<b>24</b>
Engine Components.....		24
Carburetor Component Location .....		25
<b>Diagnostics</b> .....		<b>26</b>
Engine Troubleshooting Guide .....		26
Starting Motor Troubleshooting Guide .....		27
<b>Tests and Adjustments</b> .....		<b>28</b>
Throttle Cable Check and Adjustment.....		28
Choke Plate Check and Adjustment.....		28
Governor Static Adjustment .....		30
Slow Idle Speed Adjustment .....		30
Fast Idle Speed Adjustment .....		31
Valve Clearance Check and Adjustment.....		32
Cylinder Compression Pressure Test.....		32
Crankcase Vacuum Test.....		33
Engine Oil Pressure Test .....		34
Fuel Pump Test.....		34
Spark Test.....		35
Spark Plug Gap Adjustment .....		36
Ignition Coil Air Gap Adjustment .....		36
<b>Repair</b> .....		<b>37</b>
Throttle Control Lever and Cable .....		37
Engine Removal and Installation.....		37
Muffler Removal and Installation .....		39
Air Cleaner Assembly.....		39
Carburetor Removal and Installation .....		40
Carburetor Disassembly And Assembly.....		41
Fuel Pump Replacement.....		42
Blower Housing Removal and Installation....		42
Flywheel Removal and Installation .....		43
Breather Removal and Installation .....		43
Rocker Arm Removal and Installation .....		44
Cylinder Head Removal and Installation .....		45
Cylinder Head Inspection .....		46
Recondition Valve Seats .....		48



# ENGINE - KAWASAKI (FH531V) SPECIFICATIONS

## Specifications

### General Specifications

Make	John Deere "K" Series, Air Cooled
Type	Gasoline
Model	FH531V
Horsepower (SAEJ 1940)	13.4 kW (18 hp)
Cylinders	2
Displacement	494 cm <sup>3</sup> (30 cu in.)
Stroke/Cycle	4 cycle
Bore	68 mm (2.68 in.)
Stroke	68 mm (2.68 in.)
Compression Ratio	8.3 : 1
Valves	Overhead
Lubrication	Pressurized
Oil Filter	Full Flow filter
Governor	Mechanical
Cooling System	Air Cooled
Air Cleaner	Dual Stage Paper Air Filter and Foam Precleaner
Muffler	Horizontal Discharge below frame

### Engine Oil Capacity

Without Filter	1.6 L (1.7 qt)
With Filter	1.7 L (1.8 qt)

### Tests and Adjustment Specifications

Slow Idle (governed)	1600 ± 75 rpm
Throttle Stop Screw Setting	100 rpm lower than governed setting
Fast Idle	3350 ± 50 rpm
Cylinder Compression Pressure (minimum)	390 kPa (57 psi)
Valve Clearance (cold)	0.075 - 0.125 mm (0.003 - 0.005 in.)
Valve Adjustment Screw Jam Nut Torque	6.9 N•m (61 lb-in.)
Rocker Arm Cover Cap Screw Torque	6 N•m (53 lb-in.)
Exhaust Valve ACR Movement (minimum)	0.25 mm (0.010 in.)
Crankcase Vacuum (minimum)	25 cm (10 in.) water
Oil Pressure at Fast Idle	240 - 310 kPa (35 - 45 psi)
Fuel Pump Pressure (minimum)	6.1 kPa (0.9 psi)
Fuel Pump Flow (minimum)	65 ml/15 seconds (2.2 oz/15 seconds)
Ignition Coil Air Gap	2 - 4 mm (0.008 - 0.016 in.)
Spark Plug Type	Champion RCJ8Y
Spark Plug Gap	0.75 mm (0.030 in.)
Spark Plug Torque	15 N•m (132 lb-in.)

# ENGINE - KAWASAKI (FH531V) SPECIFICATIONS

## Repair Specifications

### Cylinder Head:

Cylinder Head Flatness (Maximum Warp) ..... 0.05 mm (0.002 in.)

### Valves and Valve Lifters:

Push Rod Bend (Maximum) ..... 0.5 mm (0.020 in.)

Valve Guide ID (Maximum) ..... 6.08 mm (0.239 in.)

Valve Stem OD - Intake (Minimum) ..... 5.95 mm (0.234 in.)

Valve Stem OD - Exhaust (Minimum) ..... 5.93 mm (0.233 in.)

Valve Seating Surface Width Intake ..... 0.6 - 0.9 mm (0.024 - 0.035 in.)

Valve Seating Surface Width Exhaust ..... 0.6 - 0.9 mm (0.024 - 0.035 in.)

Valve Spring Free Length (Minimum) ..... 31.0 mm (1.220 in.)

Valve Margin (Minimum) ..... 0.35 mm (0.014 in.)

Valve Stem Bend (Maximum) ..... 0.05 mm (0.002 in.)

Valve Seat and Face Angle ..... 45°

Valve Narrowing Angle ..... 30°

### Cylinder Bore, Pistons and Rings

#### Ring Groove Side Clearance (Maximum):

Top Ring ..... 0.15 mm (0.006 in.)

Second Ring ..... 0.12 mm (0.006 in.)

Oil Ring ..... 0.20 mm (0.008 in.)

Piston Pin OD (Minimum) ..... 15.96 mm (0.628 in.)

Piston Pin Bore ID (Maximum) ..... 16.08 mm (0.633 in.)

Piston OD (Minimum) ..... 67.79 mm (2.669 in.)

0.50 mm (0.020 in.) Oversize Piston OD ..... 68.29 mm (2.689 in.)

#### Cylinder Bore Out of Round:

Wear Limit ..... 0.01 mm (0.0022 in.)

Standard ..... 0.056 mm (0.0004 in.)

#### Cylinder Bore ID:

(Standard) ..... 67.98 - 68.00 mm (2.676 - 2.677 in.)

Wear Limit (Maximum) ..... 68.10 mm (2.681 in.)

#### 0.50 mm (0.020 in.) Oversize Cylinder Bore:

Standard ..... 68.48 - 68.50 mm (2.696 - 2.697 in.)

Wear Limit (Maximum) ..... 68.60 mm (2.701 in.)

#### Piston Rings:

Ring Thickness (Top and Second Ring) (Minimum) ..... 1.40 mm (0.055 in.)

Ring End Gap - Top Ring (Maximum) ..... 0.70 mm (0.028 in.)

Ring End Gap - Second Ring (Maximum) ..... 0.78 mm (0.031 in.)

Oil Ring End Gap (Maximum) ..... 1.05 mm (0.041 in.)

Piston Ring/Groove Clearance - Top Ring (Maximum) ..... 0.15 mm (0.007 in.)

Piston Ring/Groove Clearance - Second Ring (Maximum) ..... 0.12 mm (0.006 in.)

### Connecting Rod:

Connecting Rod Small End ID (Maximum) ..... 16.05 mm (0.632 in.)

Connecting Rod Big End ID (Maximum) ..... 35.055 mm (1.380 in.)

Connecting Rod Big End ID (Undersize) ..... 34.50 mm (1.358 in.)

Connecting Rod Big End Width (Minimum) ..... 18.80 mm (0.74 in.)



# ENGINE - KAWASAKI (FH531V) SPECIFICATIONS

## Crankshaft:

Crankshaft End Play	0.09 - 0.22 mm (0.004 - 0.009 in.)
Crankshaft Runout (TIR) (Maximum)	0.05 mm (0.002 in.)
Crankshaft Main Bearing PTO Journal OD (Minimum)	34.90 mm (1.374 in.)
Crankshaft Main Bearing Flywheel Journal OD (Minimum)	34.93 mm (1.375 in.)
Crankshaft Connecting Rod Journal OD (Minimum)	34.94 mm (1.375 in.)
Crankshaft Connecting Rod Journal OD (Undersized)	34.46 mm (1.356 in.)
Crankshaft Crankpin Width (Maximum)	39.50 mm (1.56 in.)
Crankcase Cover Plain Bearing ID (Maximum)	35.15 mm (1.384 in.)

## Camshaft:

End Journal OD (Minimum)	15.985 mm (0.629 in.)
Lobe Height (Minimum)	29.131 mm (1.1469 in.)
Bearing ID (Minimum)	16.136 mm (0.635 in.)

## Oil Pump:

Rotor Shaft OD (Minimum)	10.923 mm (0.430 in.)
Rotor Shaft Bearing ID (Maximum)	11.072 mm (0.436 in.)
Outer Rotor Thickness (Minimum)	9.830 mm (0.387 in.)
Outer Rotor OD (Minimum)	40.47 mm (1.593 in.)
Inner and Outer Rotor Clearance (Maximum)	0.2 mm (0.008 in.)
Rotor Bearing Depth (Maximum)	10.23 mm (0.430 in.)
Rotor Bearing ID (Maximum)	40.80 mm (1.606 in.)
Relief Valve Spring Free Length (Minimum)	19.50 mm (0.775 in.)

## Ignition Coil

Resistance Between Primary Lead and Core	9 K ohms
Resistance Between Plug Cap and Core	8 - 11 K ohms
Ignition Coil Air Gap	2 - 4 mm (0.008 - 0.016 in.)

## Starting Motor

Maximum Amperage (No Load)	50 amps at 5000 rpm
Brush Length (Minimum)	6.4 mm (0.250 in.)
Wire Connection to Solenoid Nut Torque	9.8 N•m (84 lb-in.)

## Torque Specifications

*NOTE: Use appropriate torque wrench which will read within the inch pound range given, or convert inch pounds to foot pounds as follows: Inch-pounds/12 = Foot-pounds*

Engine Mounting Cap Screw Torque	26 N•m (230 lb-in.)
Flywheel Bolt Torque	56 N•m (41 lb-ft)
Cylinder Head and Valves Cap Screw Torque in Sequence (Lubricated)	
Final Torque	25 N•m (221 lb-in.)
Crankcase Cover Cap Screw Torque	25 N•m (221 lb-in.)
Oil Drain Plug Torque	23 N•m (200 lb-in.)
Connecting Rod End Cap Screw Torque	5.9 N•m (52 lb-in.)
Governor Lever Nut Torque	7.8 N•m (69 lb-in.)
Intake Manifold Mounting Cap Screws	6.9 N•m (61 lb-in.)

# ENGINE - KAWASAKI (FH531V) TOOLS AND MATERIALS

## Tools and Materials

### Tools

**NOTE:** Order tools according to information given in the U.S. SERVICE-GARD™ Catalog or in the European Microfiche Tool Catalog (MTC).

### Special or Required Tools

Tool Name	Tool No.	Tool Use
Hand-Held Digital Tachometer	JT05719	Used to check idle speed and starter performance.
Digital Pulse Tachometer	JT07270	Used to check idle speed and starter performance.
Compression Gauge	JDM59	Used to check engine compression.
U-Tube Manometer Test Kit	JT05698	Used to check engine crankcase vacuum.
Vacuum Gauge	JT03503	Used to check engine crankcase vacuum.
Drill Bit	6.4 mm (0.25 in.)	Throttle and choke adjustment.
Lapping Tool	- - -	Valve lapping
Dial Indicator	- - -	Automatic compression relief test, valve inspection, crankshaft end play.
Spark Plug Ground	JDM74A5	Used to prevent accidental engine starting during tests.
90° Elbow Fitting	JT03338	Used to connect pressure gauge to engine when performing Engine Oil Pressure Test.
Hose Assembly	JT03017	Used to connect pressure gauge to engine when performing Engine Oil Pressure Test.
Pressure Gauge Assembly	JT03344	Used to read engine oil pressure when performing Engine Oil Pressure Test.
Pressure Gauge	JDG356	Used to check fuel pump performance.
Spark Tester	D-05351ST	Used to check overall condition of ignition system.
Valve Spring Compressor	JDM70	Used to remove and install valve springs.
Current Gun	JT05712	Used to check starter performance.

# ENGINE - KAWASAKI (FH531V) TOOLS AND MATERIALS

## Other Materials

### Other Material

Part No.	Part Name	Part Use
M79292	MPG-2® Multipurpose Grease	Apply to engine crankshaft
	SCOTCH-BRITE® Abrasive Sheets/Pads	Clean cylinder head
	Valve Guide Cleaner	Clean valve guides
	Prussian Blue Compound	Check valve seat contact
	Lithium Base Grease	Pack oil seals
	Zinc Oxide/Wood Alcohol	Check block for cracks
	Mineral Spirits	Clean armature
	Valve Lap Compound	Lap valves
T43512 / TY9473 / LOCTITE,242	Thread Lock and Sealer (Medium Strength)	Apply to threads of throttle and choke plate screws
TY15130 / LOCTITE,395	Form-in-Place Gasket	Rocker arm cover mating surfaces
TY9375/TY9480/ LOCTITE,592	Thread Sealant (General Purpose) with TEFLON,	Apply to threads of oil pressure switch

MPG-2, is a registered trademark of DuBois USA.

LOCTITE, is a registered trademark of the Loctite Corp.

SCOTCH-BRITE, is a registered trademark of the 3M Co.

TEFLON® is a registered trademark of DuPont

## Service Parts Kits

The following kits are available through your parts catalog:

- Carburetor Repair Kit
- Gasket Kit
- High Altitude Carburetor Kit
- Piston Ring Kit
- Oversized Piston and Ring Kits
- Starting Motor Brush Kit
- Oil Pump Kit

# ENGINE - KAWASAKI (FH531V) COMPONENT LOCATION

## Component Location

### Engine Components

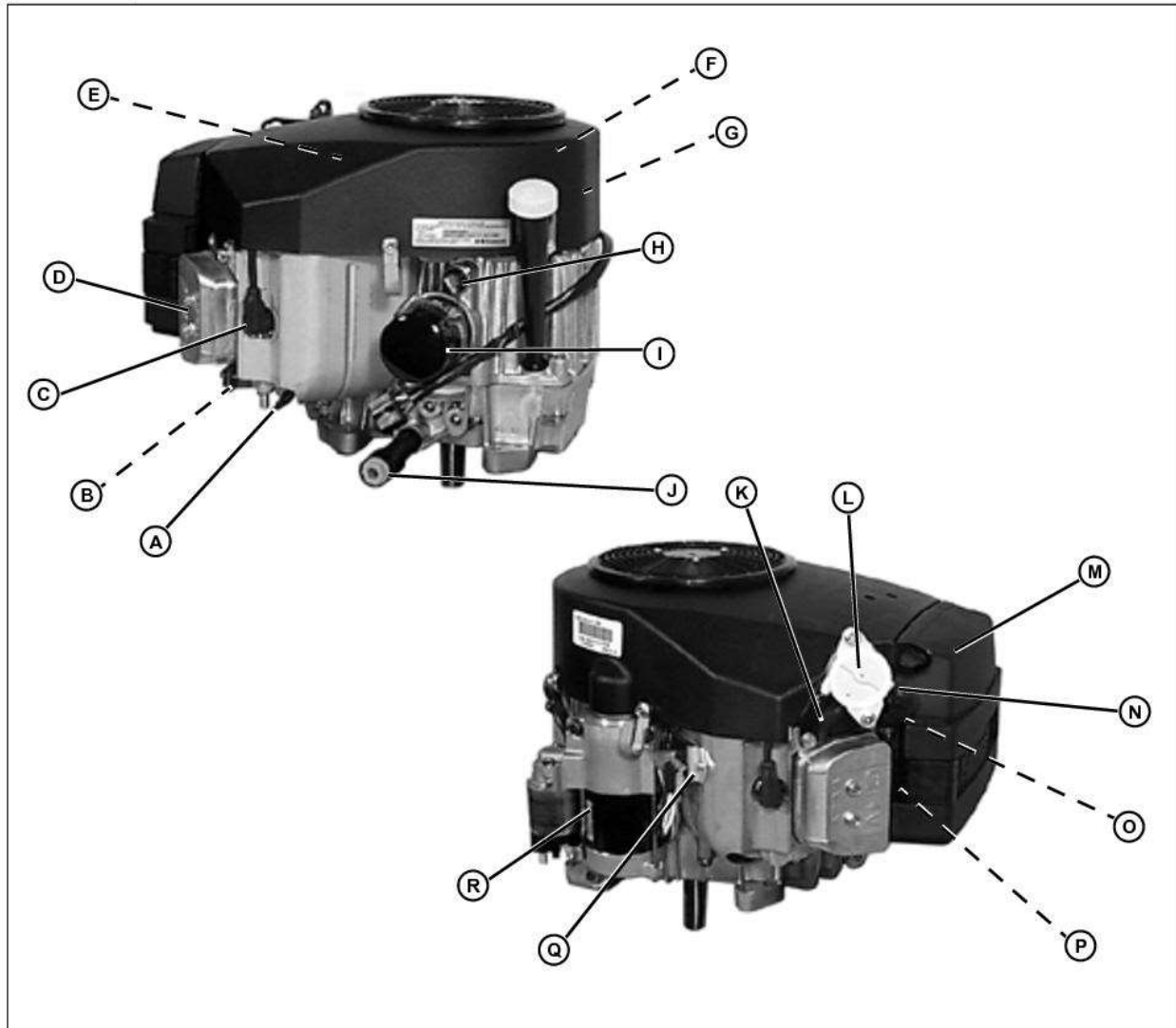

M95399 and M95400

- A - Governor Linkage
- B - Throttle and Choke Linkage
- C - Spark Plug
- D - Rocker Arm Cover
- E - Ignition Module
- F - Flywheel
- G - Stator
- H - Oil Pressure Switch
- I - Oil Filter
- J - Drain Plug
- K - Vacuum Hose
- L - Fuel Pump

- M - Air Cleaner Cover
- N - Carburetor Inlet Hose
- O - Carburetor
- P - Fuel Shutoff
- Q - Voltage Regulator/Rectifier
- R - Starting Motor

# ENGINE - KAWASAKI (FH531V) COMPONENT LOCATION

## Carburetor Component Location

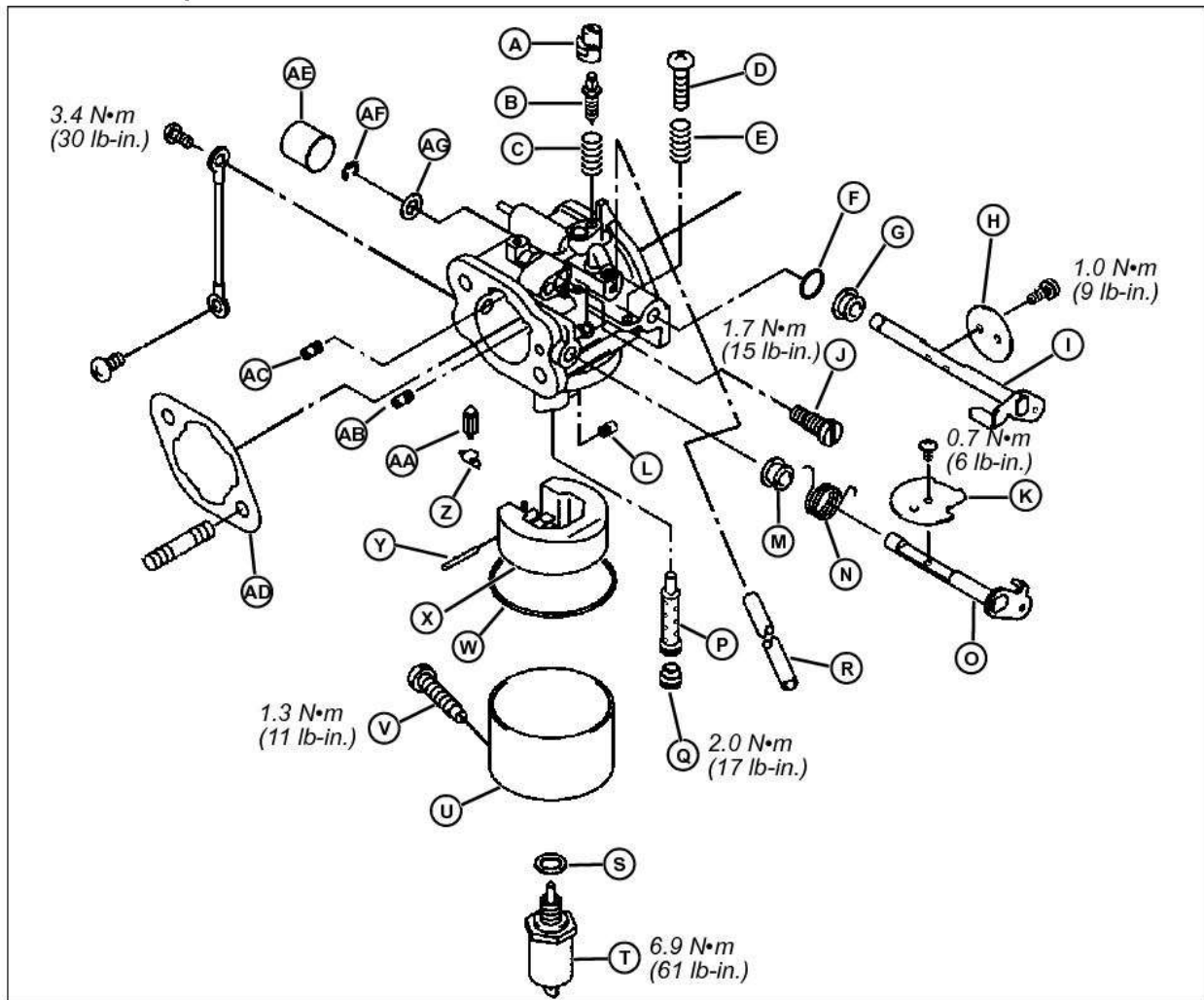

M94903

- A - Restrictor
- B - Screw
- C - Compression Spring
- D - Screw
- E - Compression spring
- F - Seal
- G - Ring
- H - Valve
- I - Shaft
- J - Main Jet
- K - Valve
- L - Jet
- M - Bushing
- N - Torsion spring
- O - Shaft
- P - Nozzle
- AA- Valve
- AB- Jet
- AC- Jet
- AD- Gasket
- AE- Cap
- AF- Clip
- AG- Washer

- Q - Valve Seat Insert
- R - Tube
- S - Washer
- T - Solenoid
- U - Float Bowl
- V - Screw
- W - Gasket
- X - Float
- Y - Pin
- Z - Clip

# ENGINE - KAWASAKI (FH531V) DIAGNOSTICS

## Diagnostics

### Engine Troubleshooting Guide



**CAUTION: Avoid Injury!** The engine may start to rotate at any time. Keep hands away from moving parts when testing.

**NOTE:** To test specific electrical components, see *Electrical Section* and refer to either *Diagnostics* or *Tests & Adjustments* for further guidance.

#### Test Conditions:

- Operator on seat.
- PTO switch in off position.
- Brake on.

### Symptom: Engine Doesn't Crank

#### (1) Are battery cables loose or dirty?

**Yes** - Tighten or clean.

**No** - Go to next step.

#### (2) Is battery fully charged? See "Battery Test" on page 311 in the Electrical section.

**No** - Charge battery. See "Charge Battery" on page 312 in the Electrical section.

**Yes** - Go to next step.

#### (3) Is key switch working correctly?

**Yes** - Go to next step.

**No** - Test switch. Replace as needed.

#### (4) Has engine seized?

**Yes** - See Engine Repair Section.

**No** - Go to next step.

#### (5) Is starting motor or solenoid defective?

**Yes** - Repair or replace. See "Starter Solenoid Test" on page 316 in the Electrical section.



**CAUTION: Avoid injury!** Keep spark plug as far away from the plug hole as possible. Gasoline spray from the open cylinders may be ignited by ignition spark and cause an explosion or fire.

### Symptom: Engine Hard To Start

#### (1) Is there a strong blue spark?

**Yes** - Go to step 3.

**No** - Replace spark plug. Recheck for spark and go to next step.

#### (2) Is there a strong blue spark?

**Yes** - Check engine starting.

**No** - Check if sparks are produced between high tension lead and ignition block. Check high tension lead, ignition coil air gap, pulser coil.

#### (3) Check compression. See "Cylinder Compression Pressure Test" on page 32. Is compression sufficient?

**Yes** - Make starting attempts a number of times, remove spark plug and observe electrodes. Go to next step.

**No** - Go to step 5.

#### (4) After starting attempts, are spark plug electrodes wet?

**Yes** - Check for excessive use of choke, plugged air cleaner, float bowl level too high.

**No** - Check fuel tank and lines.

#### (5) Is compression low?

**Yes** - Check piston rings and cylinder for wear. See "Piston Inspection:" on page 51. Inspect cylinder head. See "Cylinder Head Inspection" on page 46.

### Symptom: Engine Runs Erratically

#### (1) Is fuel delivery correct. See "Fuel Pump Test" on page 34.

**Yes** - Check for plugged air/fuel passages in carburetor. See "Carburetor Disassembly And Assembly" on page 41.

**No** - Check for contamination, or an air or vapor lock in the fuel tank and lines.

### Symptom: Engine Malfunctions At Low Speed

#### (1) Is unusual smoke emitted out of muffler?

**Yes** - Check choke. See "Choke Plate Check and Adjustment" on page 28.

**No** - Go to next step.

#### (2) Does engine rpm drop or engine stall at a certain point when throttle is gradually opened by hand?

# ENGINE - KAWASAKI (FH531V) DIAGNOSTICS

## Symptom: Engine Malfunctions At Low Speed

**Yes** - Plug in carburetor interior, clean carburetor. See "Carburetor Disassembly And Assembly" on page 41.

**No** - Go to next step.

### (3) Is air sucked through carburetor or intake manifold flanges?

**Yes** - Tighten manifold flange nuts or replace damaged gasket.

**No** - Go to next step.

### (4) Are valve clearances set correctly? See "Valve Clearance Check and Adjustment" on page 32.

**No** - Adjust valves.

## Symptom: Oil Consumption Is Excessive

### (1) Check compression. See "Cylinder Compression Pressure Test" on page 32. Is compression sufficient?

**Yes** - Check for oil leaks, high oil level, plugged oil ring groove, oil seals, clogged breather valve, plugged drain back hole in breather, incorrect oil viscosity.

**No** - Check for worn, stuck or broken piston rings, or worn cylinder bore.

## Starting Motor Troubleshooting Guide



**CAUTION: Avoid Injury!** The engine may start to rotate at any time. Keep hands away from moving parts when testing.

**IMPORTANT: Avoid damage!** If starting motor does not by turning ignition switch to Off position, disconnect negative (-) lead from battery as soon as possible.

**NOTE:** To test specific electrical components, see Electrical Section and refer to either Diagnostics or Tests & Adjustments for further guidance.

## Symptom: Starter Does Not Rotate

### (1) Is there a click sound from starter solenoid?

**Yes** - Repair starting motor. See "Starting Motor" on page 62, and "Starting Motor Disassembly and Assembly" on page 62.

**No** - Check that all starting conditions are met. Go to next step.

## Symptom: Starter Does Not Rotate

### (2) Are battery cables loose or dirty?

**Yes** - Tighten or clean.

**No** - Go to next step.

### (3) Is battery fully charged? See "Battery Test" on page 311 in the Electrical section.

**No** - Charge battery. See "Charge Battery" on page 312 in the Electrical section.

**Yes** - Go to next step.

### (4) Is key switch working correctly?

**Yes** - Go to next step.

**No** - Test switch. Replace as needed.

### (5) Has engine seized?

**Yes** - See Engine Repair Section.

## Symptom: Starter Rotates Slowly

### (1) Are battery cables loose or dirty?

**Yes** - Tighten or clean.

**No** - Go to next step.

### (2) Is battery fully charged? See "Battery Test" on page 311 in the Electrical section.

**Yes** - Go to next step.

**No** - Charge battery. See "Charge Battery" on page 312 in the Electrical section.

### (3) Has engine seized?

**Yes** - See Engine Repair Section.

**No** - Go to next step.

### (4) Is starting motor or solenoid defective?

**Yes** - Repair or replace. See "Starter Solenoid Test" on page 316 in the Electrical section.

# ENGINE - KAWASAKI (FH531V) TESTS AND ADJUSTMENTS

## Tests and Adjustments

### Throttle Cable Check and Adjustment

#### Reason:

To make sure the throttle control arm contacts the slow idle stop at slow idle.

#### Equipment:

- 6 mm (1/4-in.) Drill Bit

#### Check Procedure:

1. Park machine on level surface.
2. Turn key switch OFF.
3. Move forward/reverse pedals to NEUTRAL position. Engage parking brake.
4. Remove hood.
5. Move throttle control lever from SLOW idle to FAST position.

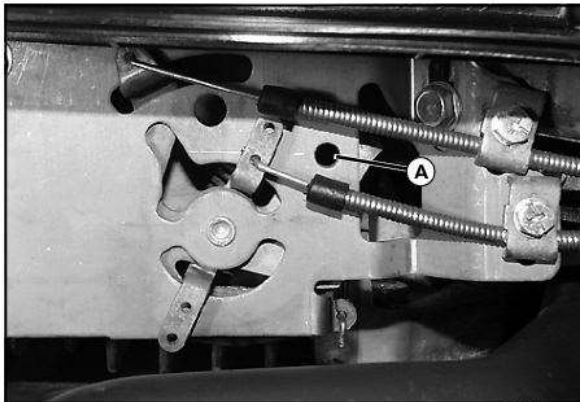

MX0572

6. Check holes (A) in control panel and throttle arm. They MUST be in visual alignment.
7. Move throttle control lever into SLOW position, then back into FAST idle position. Again, holes in control panel and throttle arm MUST be aligned.

#### Results:

- If holes align in both positions, throttle cable is OK. Check choke cable for proper adjustment.
- If holes DO NOT align, perform ADJUSTMENT Procedure.

#### Adjustment Procedure:

1. Move throttle control lever to FAST idle position.

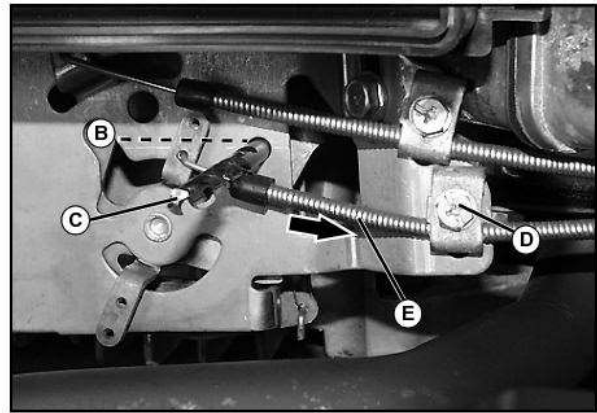

MX0573

2. Align hole in throttle arm (B) with hole in control panel. Insert a **6 mm (1/4 in.)** drill bit (C) through holes to keep throttle arm from moving. Be sure drill bit is perpendicular to the control panel.
3. Loosen screw (D).
4. Pull throttle cable (E) back (arrow) and tighten screw (D).
5. Remove drill bit.
6. Repeat CHECK Procedure.
7. Move throttle control lever through full range several times to be sure linkage is not binding.

### Choke Plate Check and Adjustment

#### Reason:

To make sure the choke plate fully opens and closes.

#### Check Procedure:

1. Remove air cleaner cover and air filter.

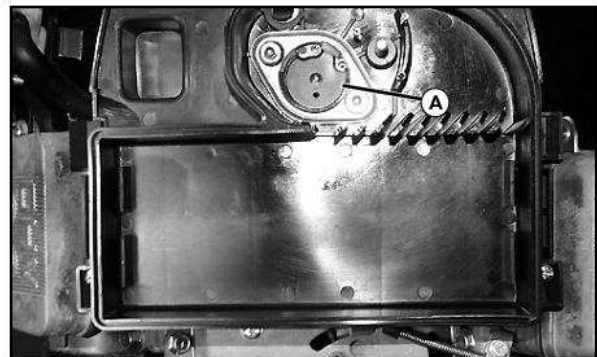

MX0574

2. Move choke control lever to full CHOKE position. Check that choke valve (A) is fully closed.
3. Move choke control lever to fully open position. Check that choke valve is fully open.



# ENGINE - KAWASAKI (FH531V) TESTS AND ADJUSTMENTS

## Results:

- If the choke plate does not fully open and close proceed with the Adjustment Procedure.

## Adjustment Procedure:

1. Move choke control lever to OFF (open) position.

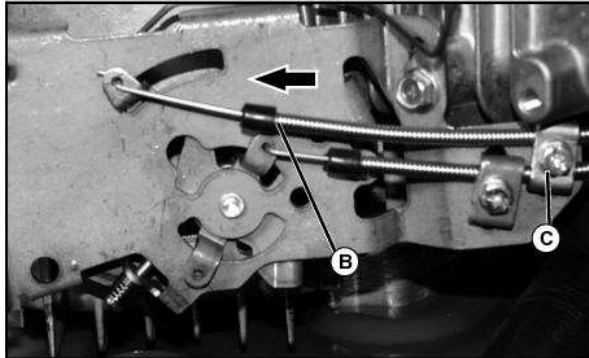

2. Loosen cable retainer screw (C).
3. Push choke cable (B) out (arrow) until the choke plate is full open and tighten screw.
4. Repeat CHECK Procedure.

## Results:

If the choke plate will not fully close or the choke control lever will not move to the fully closed position after the choke cable has been adjusted, the choke rod may not be bent to the correct position. Proceed with the following steps.

1. Remove the two screws and two nuts that hold the air cleaner base to the carburetor.
2. Carefully pull air cleaner base away from carburetor and remove crankcase vent tube from back of air cleaner base.
3. Place both nuts (D) back on carburetor studs and secure finger tight only.

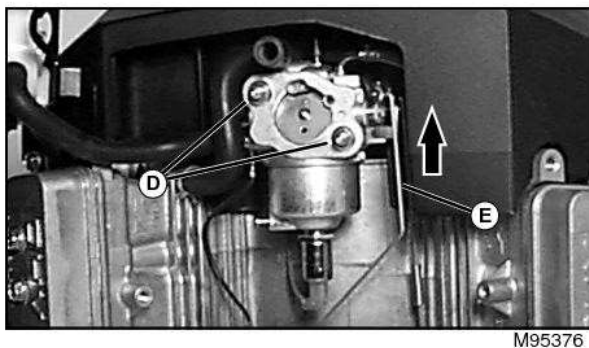

4. Try to move choke rod (E) toward carburetor (arrow). Choke rod should NOT move. If choke rod moves up, the choke plate is not fully closed.

5. Move choke control lever to OFF position.

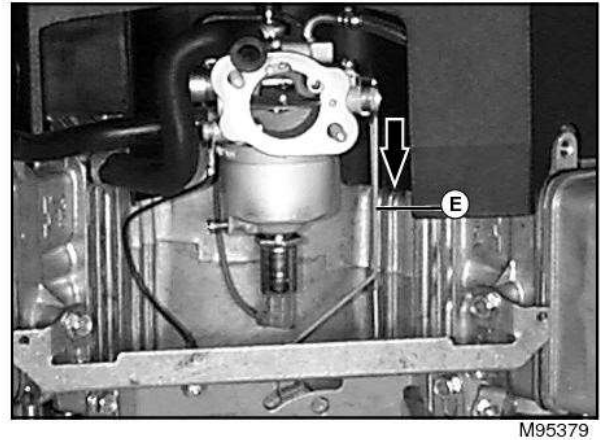

6. Try to move choke rod (E) down toward control panel (arrow). Choke rod should NOT move. If choke rod moves down, the choke plate is not fully open.

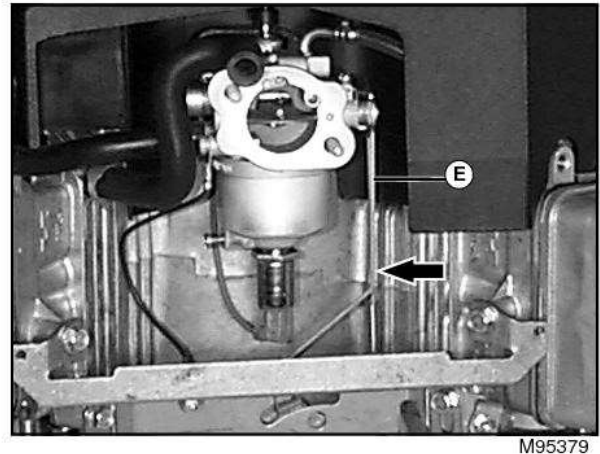

7. Carefully bend the choke rod (E) at the corner (arrow) to balance the open and closed position of the choke valve plate.

**NOTE: Bending the rod more will open the choke, while bending the rod straighter will close the choke valve.**

8. Repeat CHECK Procedure.
9. Move choke lever through full range to be sure linkage is not binding.

**Thanks very much for your  
reading, Want to get more  
information, Please click here,  
Then get the complete manual**

**JustClickHere** 

**NOTE:**

**If there is no response to click  
on the link above, please  
download the PDF document  
first, and then click on it.**

# ENGINE - KAWASAKI (FH531V) TESTS AND ADJUSTMENTS

## Governor Static Adjustment

### Reason:

To make sure the governor shaft contacts the fly-weight plunger when the engine is stopped.

### Procedure:



**CAUTION: Avoid Injury! Muffler will be HOT. Be careful not to burn hands. Allow engine and muffler to cool before adjusting the governor.**

**NOTE: Adjust throttle cable and choke plate before adjusting governor linkage.**

1. Park machine on level surface.
2. Turn key switch OFF.
3. Move forward/reverse pedals to NEUTRAL position. Engage parking brake.
4. Check throttle cable and choke plate adjustment.
5. Move throttle control lever to FAST idle position.

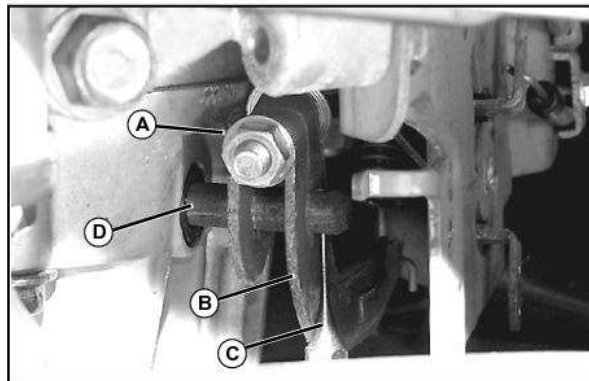

MX0578

6. Loosen nut (A).
7. Hold governor arm (B) in the fully clockwise.
8. Using a small pin (C) placed through the governor shaft (D), rotate shaft counterclockwise as far as it will go.
9. Hold governor shaft and governor arm in place and tighten nut to **7.8 N•m (69 lb-in.)**.
10. Move throttle control lever through full range to be sure linkage is not binding.

## Slow Idle Speed Adjustment

### Reason:

To set engine slow idle rpm.

### Equipment:

- JTO7270 Digital Pulse Tachometer, or
- JT05719 Photo Tachometer

### Procedure:

1. Park machine on level surface.
2. Turn key switch OFF.
3. Move forward/reverse pedals to NEUTRAL position. Engage parking brake.
4. Remove hood.
5. Ensure throttle cable and choke cable are properly adjusted.
6. Put reflective tape (if photo tachometer is used) on blower housing screen.

**NOTE: Idle mixture is factory set. Access idle mixture screw and slow idle stop screw through holes in front shroud. DO NOT force the idle mixture screw.**

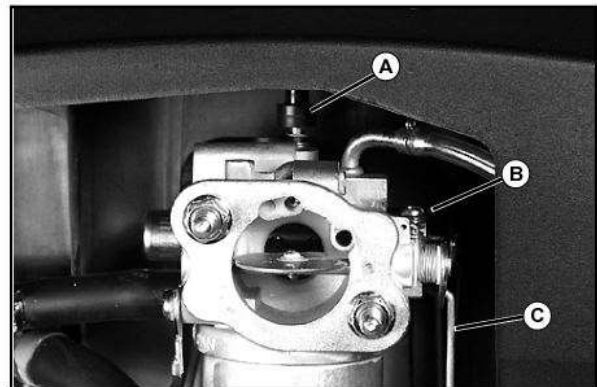

M99560

### Air Filter and Housing Removed for Clarity

7. Start and run engine at MEDIUM idle for five minutes.
8. Move throttle control lever to SLOW idle position.
9. Initial Adjustment: Turn idle mixture screw (A) clockwise until it contacts the limiter stop. Then turn idle mixture screw counterclockwise (approximately 1/2 turn) until it contacts the limiter stop. Turn idle mixture screw clockwise to midpoint.
10. Turn idle mixture screw until best idle is obtained.
11. Pull throttle lever rod (C) down until movement stops (holds the throttle lever on the carburetor in the closed position and turns the governor arm clockwise all the way when the idle stop screw (B) is contacted).